

**STUDY OF TRAPEZOIDAL STRUCTURE AS A WIDE-BAND FEED**  
**FOR A RADIO TELESCOPE**

**PROJECT REPORT**  
**(2003 – 2004)**

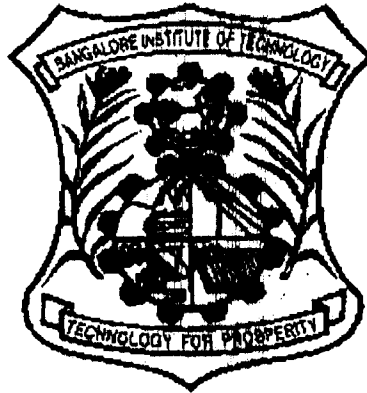

**A project report submitted in partial fulfillment of requirement for  
the award of the degree of  
BACHELOR OF ENGINEERING  
in  
TELECOMMUNICATION ENGINEERING  
of the  
VISVESWARAIAH TECHNOLOGICAL UNIVERSITY, Belgaum  
Karnataka, India**

**Submitted By**

**PRATHIMA RAO (1BI00TE019)**  
**PALLAVI MADHUSUDHAN (1BI00TE033)**

**Under the guidance of**

**External Guide:**

**Mr. A. Raghunathan**  
**Radio Astronomy Lab**  
**Raman Research Institute**  
**C. V. Raman Avenue**  
**Bangalore – 80**

**Internal Guide:**

**Mr. M. N. Sreerangaraju**  
**Asst. Professor & H.O.D**  
**Dept. of Telecom Engineering**  
**Bangalore Institute of Technology**  
**Bangalore- 04**

**DEPARTMENT OF TELECOMMUNICATION ENGINEERING**  
**BANGALORE INSTITUTE OF TECHNOLOGY**  
**K.R.ROAD, BANGALORE – 560004.**

# Bangalore Institute of Technology

K.R.Road, Bangalore-560004.

(2003-2004)

## DEPARTMENT OF TELECOMMUNICATION ENGINEERING

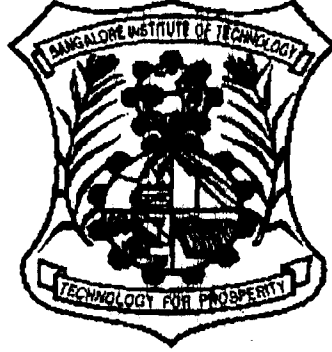

### CERTIFICATE

It is certified that the project work entitled  
**“Study of Trapezoidal Structure as a Wide-band Feed  
For a Radio Telescope”**

is a bonafide work carried out by **Prathima Rao (1BI00TE019)** and **Pallavi Madhusudhan (1BI00TE033)** in partial fulfillment for the award of the degree of **Bachelor of Engineering in Telecommunication Engineering** of the Visveswaraiah Technological University, Belgaum, Karnataka, India during the year 2003-2004.

It is certified that all corrections/suggestions indicated for internal assessment have been incorporated in the report deposited in the Department Library. The project report has been approved as it satisfies the academic requirements in respect of project work prescribed for the Bachelor of Engineering Degree.

Signature of Internal Guide

Names of the students:

1. Prathima Rao (1BI00TE019)
2. Pallavi Madhusudhan (1BI00TE033)

**External Viva:**

Name of Examiners:

1.

2.

Signature of H. D. H.  
M. N. SREE RANGAJI  
Assistant Professor & Head  
Dept. of Telecommunication Engg  
BIT, K R Road, Bangalore-04

Signature with date



May 25, 2004

## ***Certificate***

This is to certify that the project work entitled

***“Study of Trapezoidal Structure as a Wide-band Feed for a Radio Telescope”***

was carried out under my guidance by

***Prathima Rao***

***Pallavi Madhusudhan***

students of the VIII semester, Bachelor of Engineering (Telecommunication), Bangalore Institute of Technology, Bangalore, in partial fulfillment of the requirement for the award of Bachelor’s Degree in Telecommunication Engineering during the semester February 2004 – May 2004.

A. Raghunathan  
Engineer

Radio Astronomy Laboratory

# BANGALORE INSTITUTE OF TECHNOLOGY

K.R.Road, Bangalore-560004.

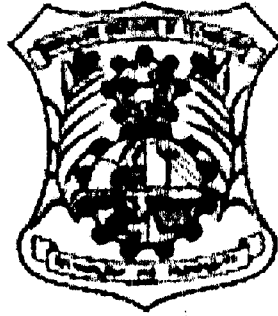

## CERTIFICATE

It is certified that the project work entitled

### **“Study Of Trapezoidal Structure As A Wide-band Feed For A Radio Telescope”**

is a bonafide work carried out by students of Telecommunication Engineering

**PRATHIMA RAO (1BI00TE019)  
PALLAVI MADHUSUDHAN (1BI00TE033)**

in partial fulfillment for the award of the degree of Bachelor of Engineering in  
Telecommunication Engineering of the Visveswaraiah Technological University,  
Belgaum, Karnataka, India during the year 2003-2004.

It is certified that all corrections/suggestions indicated for internal assessment have  
been incorporated in the report deposited in the Department Library. The project  
report has been approved as it satisfies the academic requirements in respect of  
project work prescribed for the Bachelor of Engineering Degree.

Signature of H.O.D

M. N. SREE RAO P. J. U. 6/04  
M-Tech

Assistant Professor & HOD

Dept. of Telecommunication Engg.

BIT, K R Road, Bangalore-04

Signature Of Principal

# SYNOPSIS

Astronomy is the field science involving the study of the nature of the universe. The studies are carried out by investigating the radiation coming from the sky with the help of telescopes. In radio astronomy it is done for the radiation in the radio band of the Electromagnetic spectrum with the help of radio telescopes.

The radio telescope collects the radiation emitted by the celestial object and amplifies it to detectable levels. The power levels of astronomical signals are in general extremely small and hence will be hidden completely in the man made noise.

A typical radio telescope consists of a feed, a low noise amplifier, heterodyne system and a detector. The signal collected by the feed is amplified and downconverted before detecting it. Normally feeds will be of different types depending upon the frequency of operation.

Every celestial body emits radiation at different frequencies and in order to characterize it at all those frequencies, it is very much desirable to have an antenna with a large operating bandwidth. In order to accomplish this, frequency independent antennas will be used most widely.

The trapezoidal structure is one of the wide band antennas, which can possibly be used in a radio telescope. The aim of this project is to build one of that type in the frequency range 0.5GHz to 1.5 GHz and characterize it for all its properties.

# ACKNOWLEDGEMENT

We would like to sincerely thank our guide Mr.A.Raghunathan, Radio Astronomy Lab, Raman Research Institute, whose meticulous help and guidance helped us complete this project successfully. It was his constant encouragement and technical assistance that made us work harder towards achieving our goal.

We are extremely grateful to our internal guide, Mr.M.N Sreerangaraju, Asst. Professor and H.O.D of Telecommunication Engineering, BIT, for the encouragement and guidance provided to us throughout the course of this project.

We are thankful to Mr.Udaya Shankar of Radio Astronomy Lab, RRI who was a source of inspiration for us during our project.

We are highly indebted to Mr.Gopalkrishna M.R, Mr.Chandrashekara K, Mr.Raghavendra Rao K.B and Ms.Sandhya P of Radio Astronomy Lab, RRI for the assistance provided to us.

We would like to express our heartfelt gratitude to Mr.Dhamodaran V, Mr.Gokulchandran V, Mr.Mohandas K.M and Mr.Gopal N of the Mechanical Department, RRI for their untiring efforts in the fabrication of the antenna.

We wish to thank Mr.Patil Y.M and Ms.Vrinda Benegal of the Library and also Mr.Raju Varghese of the Photolab and Graphics Department, RRI for their kind co-operation.

We are grateful to Mr.Srikanth for his efforts in helping us in the completion of our project. We would also like to mention a special word of thanks to Mr.Gangadhar and Mr.Sarabagopalan G who helped us in more ways than one.

We would like to thank all staff members of Department of Telecommunication, BIT who extended their support whenever needed. Finally, we thank everybody at the Radio Astronomy Lab, RRI. Working with them has been an immense pleasure.

Prathima Rao

Pallavi Madhusudhan

# CONTENTS

## ***CHAPTER 1 : ANTENNA PARAMETERS***

1.1	Radiation Mechanism	2
1.2	Radiation Pattern	3
1.3	Radiation Resistance	6
1.4	Antenna Efficiency	6
1.5	Bandwidth	7
1.6	Input Impedance	7
1.7	VSWR	7
1.8	Return Loss	7
1.9	Antenna Gain	7
1.10	Phase Center	8
1.11	Antenna Directivity	8
1.12	Field Regions	8
1.13	Balun	10

## ***CHAPTER 2 : CLASSIFICATION OF ANTENNAS***

2.1	Current Elements	12
2.2	Travelling Wave Antennas	13
2.3	Aperture Antennas	14
2.4	Array Antennas	14
2.5	Frequency Independent Antennas	15
2.6	Log Periodic Toothed Trapezoidal Antenna	18

## ***CHAPTER 3 : DESIGN OF TRAPEZOIDAL STRUCTURE***

3.1	Design Characteristics	21
3.2	Balun Design	27
3.3	Design of Trapezoidal Structure	28
3.4	Experimental Setup for Measurement of Return Loss	30

### 1.10 Phase Center

The phase center is defined as a point inside the antenna from which the spherical waves radiated by the antenna originates..

### 1.11 Antenna Directivity

Directive gain,  $D_g$ , is defined as the ratio of the radiation intensity in a given direction to the radiation intensity of a reference antenna in the same direction. The reference is taken to be an isotropic source.

$$D_g = \frac{U}{U_0} \dots\dots\dots (1.7)$$

Directivity,  $D_0$ , is the value of the directive gain in the direction of the maximum value. Stated in simple terms, the directivity of a nonisotropic source is equal to the ratio of the maximum radiation intensity over that of an isotropic source.

$$D_0 = \frac{\text{Maximum radiation intensity}}{\text{Radiation intensity of isotropic source}} = \frac{U_{\max}}{U_0} \dots\dots\dots (1.8)$$

Where,

$U_0$  = radiation intensity of an isotropic source

Directivity is also related to the beam solid angle  $\Omega_A$  as shown below

$$D_0 = 4 \Pi / \Omega_A \dots\dots\dots (1.9)$$

Where,

$\Omega_A$  = beam solid angle

### 1.12 Field Regions

The space surrounding an antenna is subdivided into three regions (or zones). They are respectively termed as reactive near-field region, radiating near-field (Fresnel) region and far-field (Fraunhofer) region as shown in Figure 1.6. The general



characteristics of the field distributions in each region can be established, although the boundaries of the regions are not defined precisely.

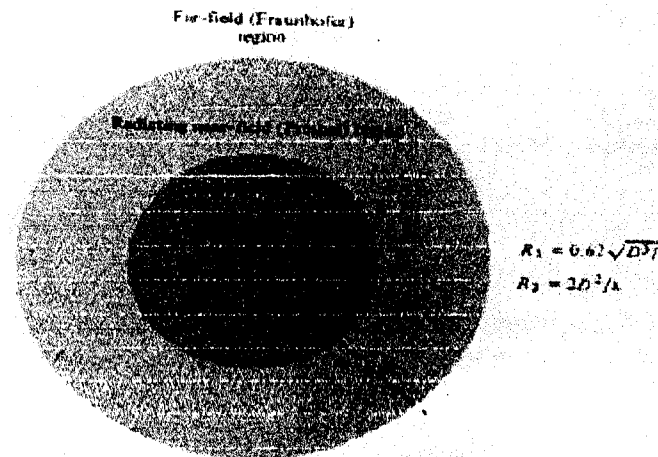

Fig 1.6 : Field Regions Of An Antenna

### ***Reactive near-field region:***

This is the region immediately surrounding the antenna where the reactive field dominates. For most antennas, the outer boundary of the region is commonly taken to exist at a distance given by

$$R < 0.62 \sqrt{D^3 / \lambda} \quad \dots \dots \dots (1.10)$$

Where

$\lambda$  = the wavelength

D = the largest dimension of the antenna

### ***Radiating-field (Fresnel) region:***

It is defined as the field of an antenna between the reactive near field region and far-field region wherein the radiation fields predominate and wherein the angular field distribution is dependent on the distance from the antenna. This field is found between  $R \geq 0.62 \sqrt{D^3 / \lambda}$  and  $R < 2D^2 / \lambda$  where R is the distance-measured from the center of the antenna.

***Far-Field (Fraunhofer) region:***

It is defined as “that region of the field of an antenna where the angular field distribution is essentially independent of the distance from the antenna “.

The far field distance exists in regions beyond

$$R \geq 2 D^2 / \lambda \quad \dots\dots\dots (1.11)$$

This forms the inner boundary of the Fraunhofer region and the outer boundary is taken to be infinity.

**1.13 Balun**

It is an impedance matching transition from unbalanced impedance to a balanced two-conductor line.

## ***CHAPTER 2***

---

# ***CLASSIFICATION OF ANTENNAS***

## Classification of Antennas

Antennas can be classified depending on their frequency of operation. For frequency of operation in the range of 10KHz - 1GHz, current elements like patch antennas, monopoles, dipoles, loops etc can be used. For a frequency range of 1MHz- 10GHz, traveling wave antennas such as log periodic antennas, rhombic antennas, helices etc will be used. Arrays made out of dipoles, helices, log periodic dipoles are used for the frequency range of 5MHz- 50GHz and aperture type of antennas are extensively used for frequencies from 1GHz to few hundred GHz. Often there is a requirement in radio astronomy for an antenna having wide band coverage, very low side lobes and good cross polarization.

A brief description of different antennas belonging to various categories as mentioned before is given below along with their important electrical characteristics.

### 2.1 Current elements

Element antennas are much lesser than a wavelength in extent. They are also simple in structure and their properties are not sensitive to the construction details. Current elements are used at frequencies below the microwave regions. The examples are monopoles, dipoles, loops, slots, stubs, patch, wire, biconical antennas, etc

#### 2.1.1 Dipole Antennas

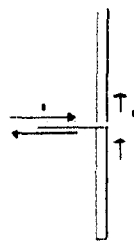

**Fig 2.1: Electric Dipole**

Two straight rods split near the middle, and fed from a balanced line make up a dipole. They are half wavelength long and operate at low frequencies. Their typical bandwidth is about 10%. They do not exhibit symmetrical in their E and H plane radiation patterns.

## 2.2 Traveling Wave Antennas

A travelling antenna is defined as an antenna for which the fields and currents that produce the antenna pattern may be represented by one or more travelling waves usually in the same direction. They can be in various forms and generally have a length of many wavelengths. The travelling wave feature improves pattern and produces wider bandwidth. Some examples of traveling antennas are long wire, rhombic, long slots in waveguide and helical antennas.

### 2.2.1 Helical Antennas

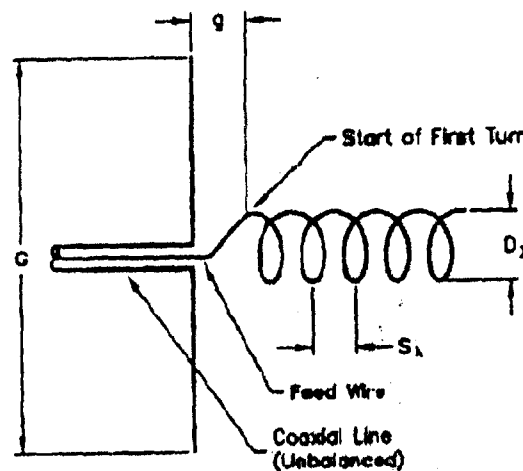

Fig 2.2: Helical Antenna

A single wire wound in a helix is the simplest form of a helical antenna. It can operate in many modes, the most common being the normal (broadside) and axial (endfire) modes. The axial mode, however, is more practical because it can achieve circular polarization over a wider bandwidth (2:1) and is more efficient. As the length of the antenna increases, its frequency bandwidth shrinks, but the gain increases.

## **2.3 Aperture Antennas**

Aperture antennas have a physical opening through which propagating electromagnetic waves flow. The pattern has a narrow main beam, which leads to high gain. For a fixed aperture size, the main beam pattern narrows down as frequency increases. These types of antennas are very useful for aircrafts and spacecrafts application, because they can be easily flush-mounted on the skin of the aircraft and spacecraft. The examples of these antennas are parabolic reflector, horn antennas, lens antennas and circular apertures

### **2.3.1 Horn Antennas**

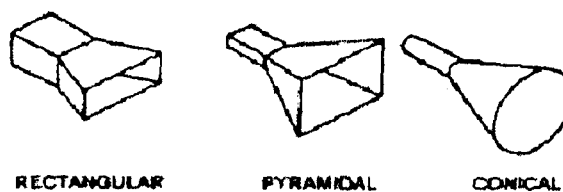

**Fig 2.3: Various Horn Antennas**

This antenna is used for the transmission and reception of microwave signals. The bandwidth of a horn is generally found to be 2: 1. A drawback of this antenna is that very high gain requires an excessive horn length.

## **2.4 Array Antennas**

Array antennas are made up of a matrix of discrete sources, which radiate out individually. The pattern of the array is determined by the relative amplitude and phase of the excitation fields of each source and the geometric spacing of the sources. The total radiation pattern is the multiplication of the pattern due to an individual source or element. To achieve high directivity, it depends on individual sources and the element factor. Typical elements in an array are dipoles, monopoles, slots in waveguides and microstrip radiators. Some examples of arrays of elements are endfire, log periodic arrays, etc

## **2.5 Frequency Independent Antennas**

Frequency independent antennas are capable operating over a large bandwidth. Frequency Independent antennas exhibit constant input impedance over a wide range of frequencies.

### **2.5.1 Properties of Frequency Independent antennas**

An antenna is said to be frequency independent provided its shape is specified entirely by angles. In other words, the dimensions of this class of antennas when expressed in wavelengths will be same at every frequency.

A self-complementary structure is a planar structure in which the metal area is congruent to the open area. It has been shown that the product of impedances of the two complementary structures equals the square of  $60\pi$ . Therefore a self-complementary structure has an impedance of  $60\pi$  ohm, independent of frequency. This principle has been used in the log periodic structure to maintain constant impedance with frequency.

### **2.5.2 Geometry of frequency independent antennas**

Consider an antenna whose geometry is described by the spherical co-ordinates  $(r, \theta, \varphi)$ , with two terminals infinitely close to the origin and symmetrically disposed along the  $\theta = 0, \pi$ - axes. The surface or an edge on the surface is described by a curve

$$r = F(\theta, \varphi) \quad \dots\dots\dots (2.1)$$

where  $r$  represents the distance along the surface or edge. If the antenna is to be scaled to a frequency  $k$  times lower than the original frequency, the antenna's physical surface must be made  $k$  times greater to maintain the same electrical dimensions. Thus the new surface is described by

$$r' = k F(\theta, \varphi) \quad \dots\dots\dots (2.2)$$

the two surfaces are identical and congruent. Congruence can be established by a rotation in  $\varphi$ . For the second surface to achieve congruence with the first, it is rotated by an angle  $C$ , so that

$$K. F(\theta, \varphi) = F(\theta, \varphi + C) \quad \dots\dots\dots (2.3)$$

The angle of rotation  $C$  depends on  $K$  but neither depends on  $\theta$  nor  $\varphi$ . Physical congruence implies that both antennas behave identically at both frequencies. Since the pattern will rotate by  $C$  in  $\varphi$  with frequency, its shape will be unaltered. Thus the impedance and pattern will be frequency independent.

Differentiating equation 2.2 with respect to  $C$ , we get

$$\begin{aligned} \frac{d}{dC} [K F(\theta, \varphi)] &= \frac{dk}{dC} F(\theta, \varphi) = \frac{\partial}{\partial C} [F(\theta, \varphi+C)] \\ &= \frac{\partial}{\partial(\varphi+C)} [F(\theta, \varphi+C)] \end{aligned} \quad \dots\dots\dots (2.4)$$

Differentiating with respect to  $\varphi$ , we get

$$\begin{aligned} \frac{d}{d\varphi} [K F(\theta, \varphi)] &= K \frac{\partial F(\theta, \varphi)}{\partial \varphi} = \frac{\partial}{\partial \varphi} [F(\theta, \varphi+C)] \\ &= \frac{\partial}{\partial(\varphi+C)} [F(\theta, \varphi+C)] \end{aligned} \quad \dots\dots\dots (2.5)$$

Upon equating 2.4 and 2.5,

$$\frac{dK}{dC} F(\theta, \varphi) = K \frac{\partial F(\theta, \varphi)}{\partial \varphi} \quad \dots\dots\dots (2.6)$$

Substituting equation 2.1 in 2.6, we have

$$\frac{1}{K} \frac{dK}{dC} = \frac{1}{r} \frac{\partial r}{\partial \varphi} \quad \dots\dots\dots (2.7)$$



Since the left hand side of this equation is independent of  $\theta$  and  $\varphi$ , a general form for the surface  $r = F(\theta, \varphi)$  of the antenna is given by

$$r = F(\theta, \varphi) = e^{a\varphi} f(\theta) \quad \dots\dots\dots (2.8)$$

where,  $a = \frac{1}{K} \frac{dK}{dC}$

And  $f(\theta)$  is a completely arbitrary function. General solution of the surface as a function of  $\theta$  and  $\varphi$  is given by equation 2.8.

### **2.5.3 Classification of Frequency independent antennas**

There are three different classes of frequency Independent antennas, namely

1. Equiangular spiral antennas
2. Conical spiral antennas
3. Log periodic antennas

Equiangular spiral antenna is one of the geometrical configurations whose surface can be specified entirely by angles. The radiation for this spiral is right hand circularly polarized for one lobe and left hand circularly polarized for the other lobe.

Conical spiral antennas are essentially planar spiral antennas. Conical antennas are mainly used for satellite communication, broadband surveillance, and command guidance and control. The families of conical antennas operate at frequencies ranging from 400-12,000 MHz.

A log- periodic antenna is one, whose electrical properties such as input impedance, pattern, directivity, beamwidth and side-lobe levels, vary as a function of the logarithm of frequency. It has constant input impedance, which is independent of frequency. If the input impedance is plotted as a function of logarithm of frequency, it will be periodic with each cycle being exactly identical to the preceding one. Hence such antennas are called

log periodic antennas. The variation of input impedance as a function of frequency is shown in the figure 2.4.

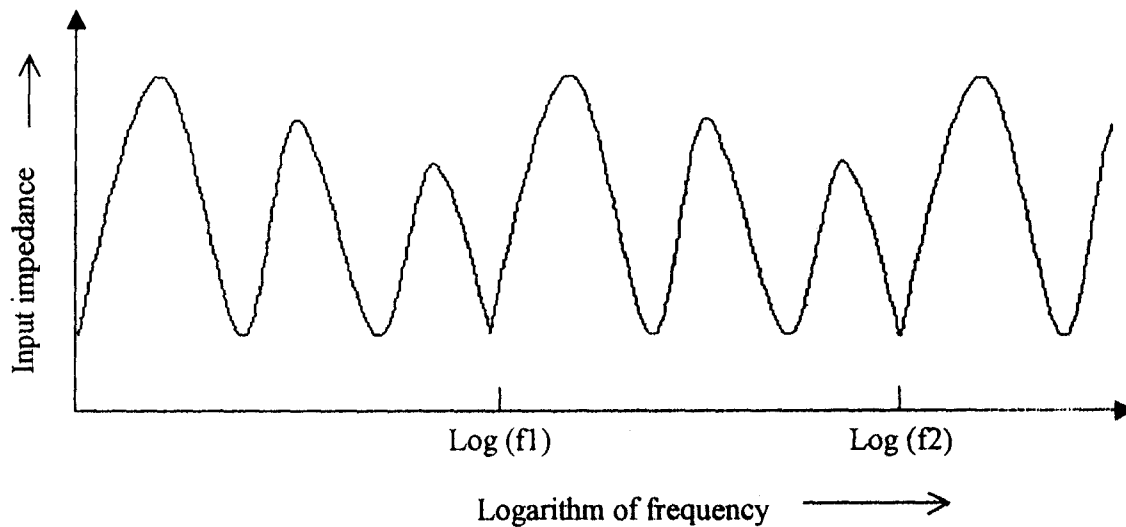
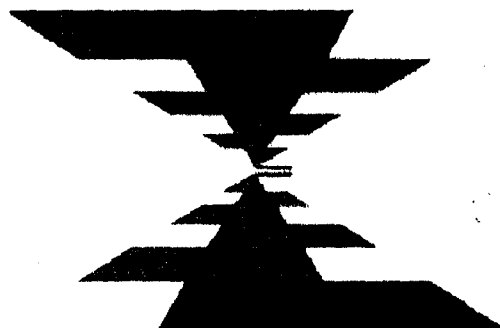

**Fig 2.4 : Variation of input impedance with Logarithm of frequency**

Log Periodic antennas exhibit constant input impedance over a wide range of frequencies. A drawback, however, is that they do not have good E and H plane radiation patterns. This disadvantage is overcome in the trapezoidal structure.

## **2.6 Log periodic Toothed Trapezoidal Antenna**

The Trapezoidal structure belongs to the class of Log- periodic antennas discussed above. It is a frequency independent antenna, which is found to self-complementary.



**Fig 2.5: Log- Periodic Toothed Trapezoidal Antenna**

This antenna radiates essentially a unidirectional linearly polarized beam in which the electric field is parallel to the teeth. Its electrical properties repeat periodically with the logarithm of frequency. Since variation within one period is generally small they will similarly be small over many periods, leading to a very wide band antenna. The two halves of the structure are fed by means of a balanced transmission line connected to the apices.

### **2.6.1 Advantages of the Trapezoidal Structure over the conventional planar Log Periodic antenna**

We know that the E and H plane radiation patterns are not symmetrical for a log periodic antenna. This disadvantage has been overcome in the trapezoidal structure. The Trapezoidal structure is capable of a very high bandwidth of operation. It is found to be as high as 10:1. The E and H Planes show symmetry in their radiation patterns and the beamwidth of the antenna can be directly controlled by varying the angle between the planar structures. The input impedance remains constant at all frequencies due to its self-complementary structure.

***CHAPTER 3***

---

***DESIGN OF TRAPEZOIDAL STRUCTURE***

### 3.1 Design characteristics of the Trapezoidal Antenna

The log-periodic trapezoidal structure is designed such that its electrical properties repeat as a function of logarithm frequency.

Generally, the H plane radiation pattern is much wider than the E plane radiation pattern in a log periodic antenna. This drawback is overcome in the trapezoidal structure by separating the two halves of the log periodic antenna by some angle  $\psi$ . By doing so the H plane radiation pattern can be made equal to the E plane radiation pattern, thus making the patterns symmetrical. A typical trapezoidal structure is shown in figure 3.1.

#### 3.1.1 Design parameters of the Trapezoidal structure

The various design parameters of the trapezoidal structure are

- (i) Lengths of biggest and smallest finger
- (ii) The dimensionless ratio,  $\tau$
- (iii) Angles  $\alpha$  and  $\psi$

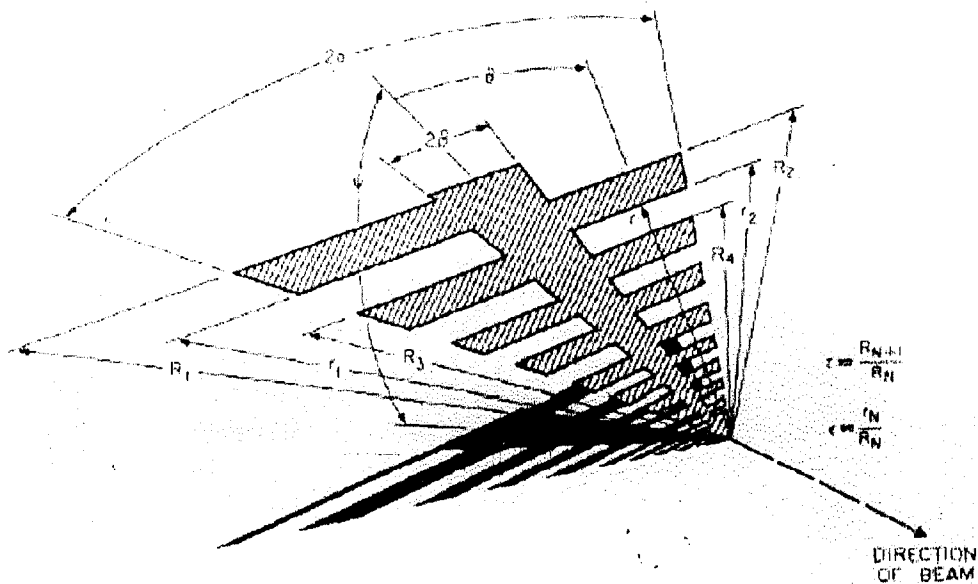

**Fig 3.1 : A typical Trapezoidal structure**

The lengths of the biggest and the smallest fingers are determined by the lower and higher cut-off frequencies.  $\tau$  represents the span in the logarithmic frequency spectrum over which the characteristics of the structure repeat. Angle  $\alpha$ , is the included half angle of the structure. This angle is said to have an effect on the phase center of the antenna. Angle  $\psi$ , is the angle between the two planar structures of the antenna. It controls both phase center and beamwidth in the H plane.

Let us now look into some of the basic equations governing the design of the trapezoidal structure.

If  $f_1$  and  $f_2$  are two frequencies at which the response of the antenna remains the same, then those two frequencies are related to each other by the equation given below

$$f_2 = f_1 / \tau$$

Similarly if  $f_3$  and  $f_1$  are two frequencies, where the response remains the same, and where  $f_3 > f_2$ , the relation between  $f_1$  and  $f_3$  is given by

$$f_3 = f_1 / \tau^2$$

In general, this can be written as,

$$f_n = f_1 / \tau^{n-1}$$

Where,

$$n = 1, 2, 3, 4, \dots, n$$

$f_1$  = lowest frequency

$f_n$  = highest frequency

The properties of a log periodic toothed planar antenna depend upon  $\tau$ . It has been found experimentally that the half power beamwidth increases with the increasing value of  $\tau$  as shown in the figure 3.2.

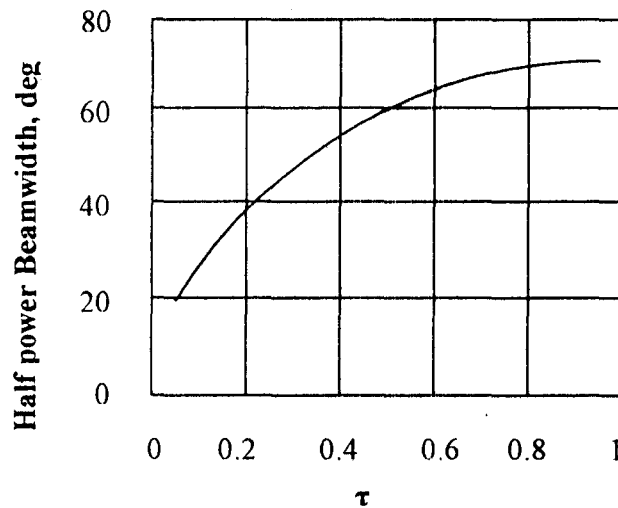

**Fig 3.2 : Complementary Antenna Beamwidth**

For a given included angle,  $\alpha$ , of the structure, there is a minimum value of the design ratio  $\tau$  which can be used. For values of  $\tau$  smaller than this minimum, the pattern breaks up considerably and for larger values the beamwidth will decrease. The variation of  $\alpha$  with respect to  $\tau$  and 3 dB beamwidth is given by figure 3.3.

The approximate minimum value of  $\tau$ , which can be used, is plotted in this figure as a function of the parameter  $\alpha$ . The E and H plane beamwidths for this minimum value of  $\tau$  are shown as solid lines. The dashed curves for E and H plane beamwidths corresponds to the dashed curve for  $\tau$ , which is somewhat larger than the minimum value. It is noticed that the E and H plane beamwidths decrease as  $\alpha$  is decreased and  $\tau$  is increased. There is also, a relation between the values of  $\alpha$  and  $\tau$ . As  $\alpha$  increases, the corresponding value of  $\tau$  decreases and vice versa.

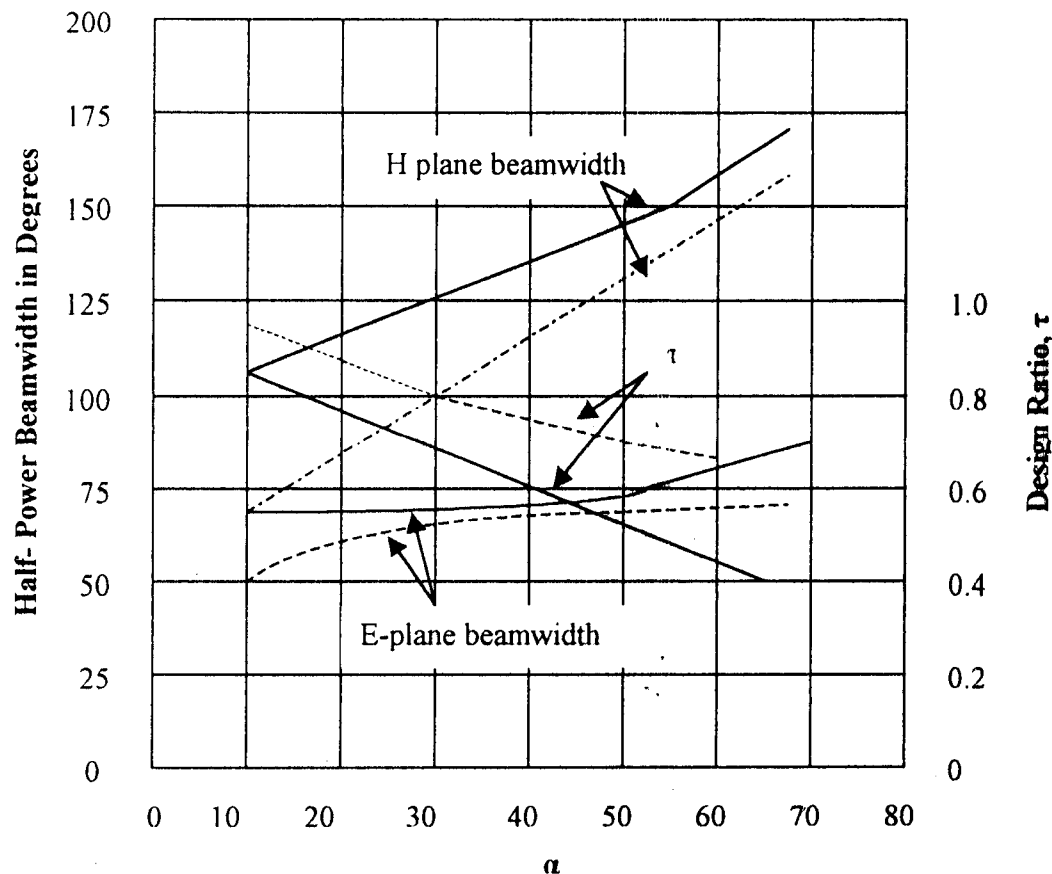
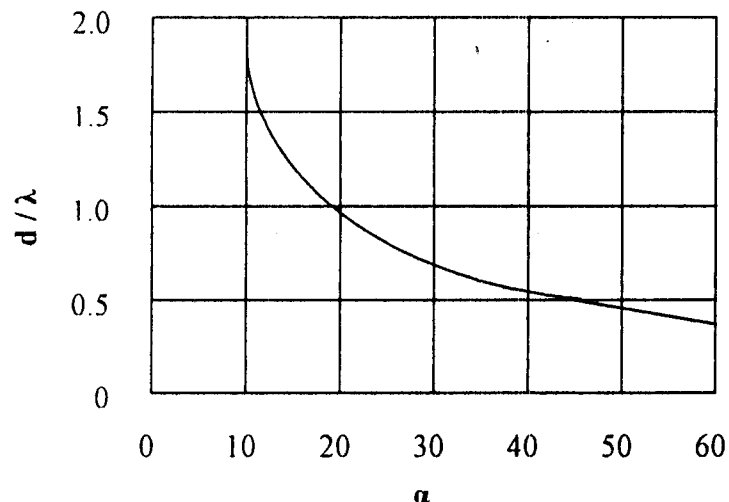

**Fig 3.3: Pattern Characteristics of Wire Trapezoidal Element**

The above figure demonstrates the variation of the E and H plane beamwidths of a single half structures with wire trapezoidal teeth as a function of the design parameter  $\alpha$ . The E plane is defined as the plane, which includes the half structure, and the H plane is the normal plane, which includes the centerline of the half structure.

The phase center of a log periodic half structure does not lie at the vertex; rather it lies some distance 'd' behind the vertex. Figure 3.4 shows the distance of the phase center from the vertices as a function of  $\alpha$  for a wire trapezoidal tooth structures. For values of  $\alpha$  less than  $60^\circ$  and for values of  $\tau$  given in the previous figure, the position of the phase center is essentially independent of  $\tau$ .





**Fig 3.4 : Distance from vertex to phase center as a function of  $\alpha$**

The angle  $\Psi$  is defined as the angle between the two planes of the antenna. The figure 3.5 gives the variation in  $-10\text{dB}$  beamwidth as a function of  $\Psi$ . For a value of  $\Psi = 60^\circ$  the E and H plane beamwidths are nearly equal to about  $100^\circ$  and such a tooth structure would therefore provide a circularly symmetrical illumination for a suitable paraboloidal reflector.

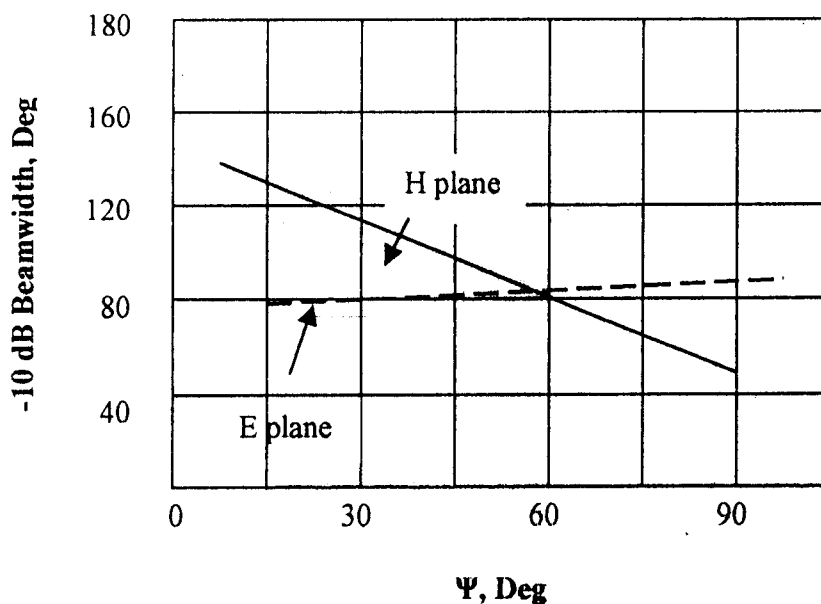

**Fig 3.5 : E and H plane  $-10\text{dB}$  Beamwidths**

Figure 3.6 gives the distance in wavelengths in both E and H plane phase centers from the apex of the structure.

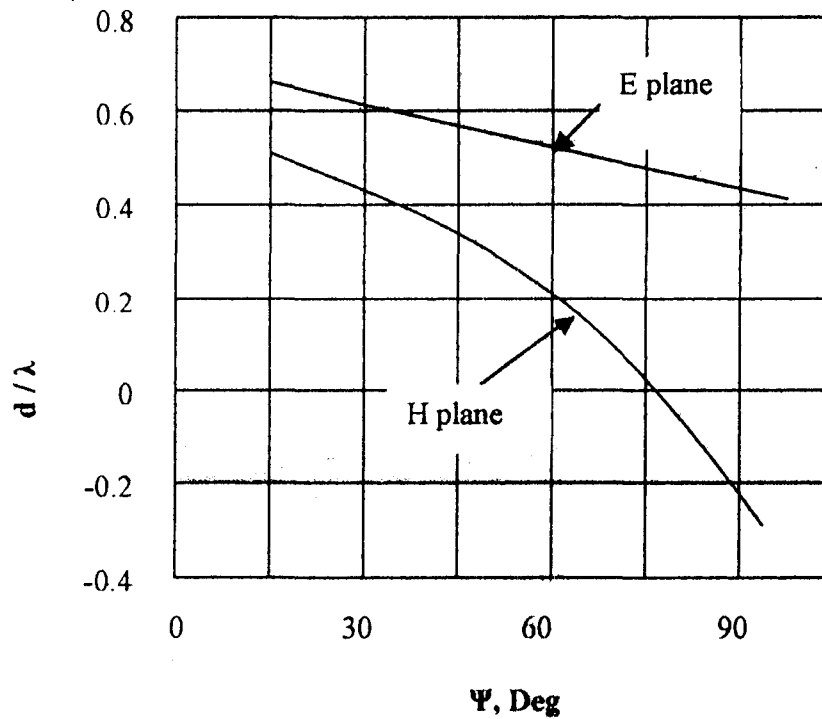

**Fig 3.6 : Location of phase center vs  $\Psi$**

Experimental data in the literature is found extensive. We have designed the trapezoidal structure by assigning fixed values for  $\alpha$ ,  $\beta$  and  $\tau$  as suggested by the literature and varying only the parameter  $\Psi$ . We have chosen the value of  $\Psi$  for maintaining equal 10dB beamwidths in the E and H planes.

### 3.2 Balun Design

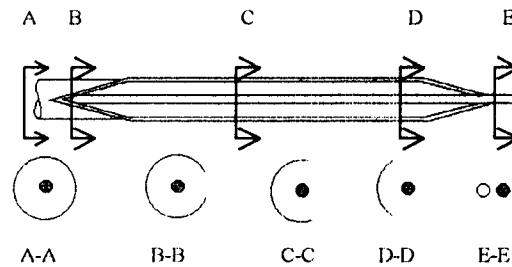

**Fig 3.7 : The Split Tapered Coax Balun**

The balun is basically an impedance matching transition from coaxial line to a balanced two conductor open line. The transition is accomplished by opening the outer wall of the coax so that the cross section view shows the sector of the outer conductor removed.

It starts with a coax cable of unbalanced impedance at the lower end. The outer conductor is slowly peeled away until it becomes a two-wire transmission line with balanced impedance at the upper end.

The advantage of this balun over other baluns is that it has a bandwidth approaching 100 : 1.

### **3.3 Design**

The experimentally optimized values for the trapezoidal structure are given below:

- (i)  $\alpha = 45^\circ$
- (ii)  $\psi = 60^\circ$
- (iii)  $\tau = 0.707$

The value of  $\psi$  is chosen to be  $60^\circ$  in order to make the E and H plane patterns symmetrical. The antenna is designed to operate in the frequency range of 500MHz to 5GHz. The lengths of the biggest and smallest fingers are then determined by equations 2.1 and 2.2 respectively.

$$\begin{aligned}
 l_{\max} &= \lambda_{\max} / 2 && \dots\dots\dots (2.1) \\
 &= c / (2 \cdot f_{\min}) \\
 &= 3 \cdot 10^8 / 500 \cdot 10^6 \\
 &= 0.3 \text{ m}
 \end{aligned}$$

$$\begin{aligned}
 l_{\min} &= \lambda_{\min} / 2 && \dots\dots\dots (2.2) \\
 &= c / (2 \cdot f_{\max}) \\
 &= 3 \cdot 10^8 / 5000 \cdot 10^6 \\
 &= 0.03 \text{ m}
 \end{aligned}$$

The various dimensions  $R_1, R_2, \dots, R_n$  and  $r_1, r_2, \dots, r_n$  as shown in fig 3.1 are calculated using the relations given by equations 2.3 and 2.4. The table 2(a) gives the values obtained.

$$R_{(n+1)} / R_{(n)} = \tau = 0.707 \quad \dots\dots\dots (2.3)$$

$$\sqrt{\tau} = r_{(n)} / R_{(n)} = 0.8408 \quad \dots\dots\dots (2.4)$$

The table below gives the calculated distances of the teeth from the apex.

R	(meters)	r	(meters)
R8	0.392	r8	0.329
R7	0.277	r7	0.234
R6	0.196	r6	0.165
R5	0.138	r5	0.116
R4	0.098	r4	0.082
R3	0.069	r3	0.058
R2	0.049	r2	0.048
R1	0.035	r1	0.029

**Table 3(a): Trapezoidal Structure dimensions**

### **3.4 Experimental setup for the measurement of Return Loss of the antenna**

Experimental setup for the measurement of Return loss of the antenna is as shown in figure 6.3. It consists of a scalar network analyzer (HP 8757D), a synthesized sweeper (HP 83752A) and a directional bridge.

Initially the setup was made without connecting the antenna. The frequency range is set between 0.5GHz to 5 GHz

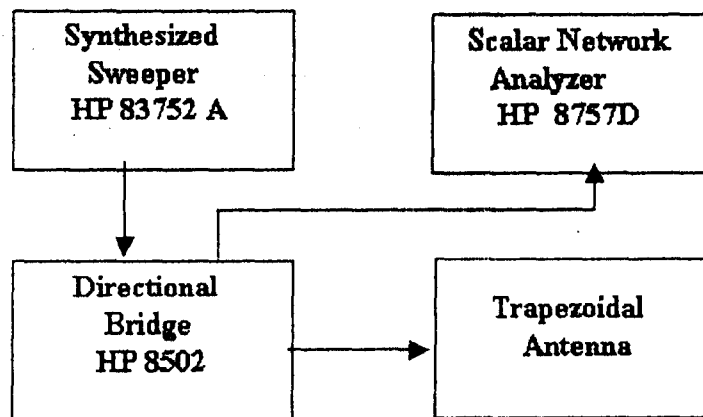

**Fig 3.8 Experimental setup for measuring Return loss**

The power level was set to 0dBm. Then the Antenna is connected in to the directional bridge. The return loss of the antenna was measured and was found to be -10dB as shown by the graph on page 31.

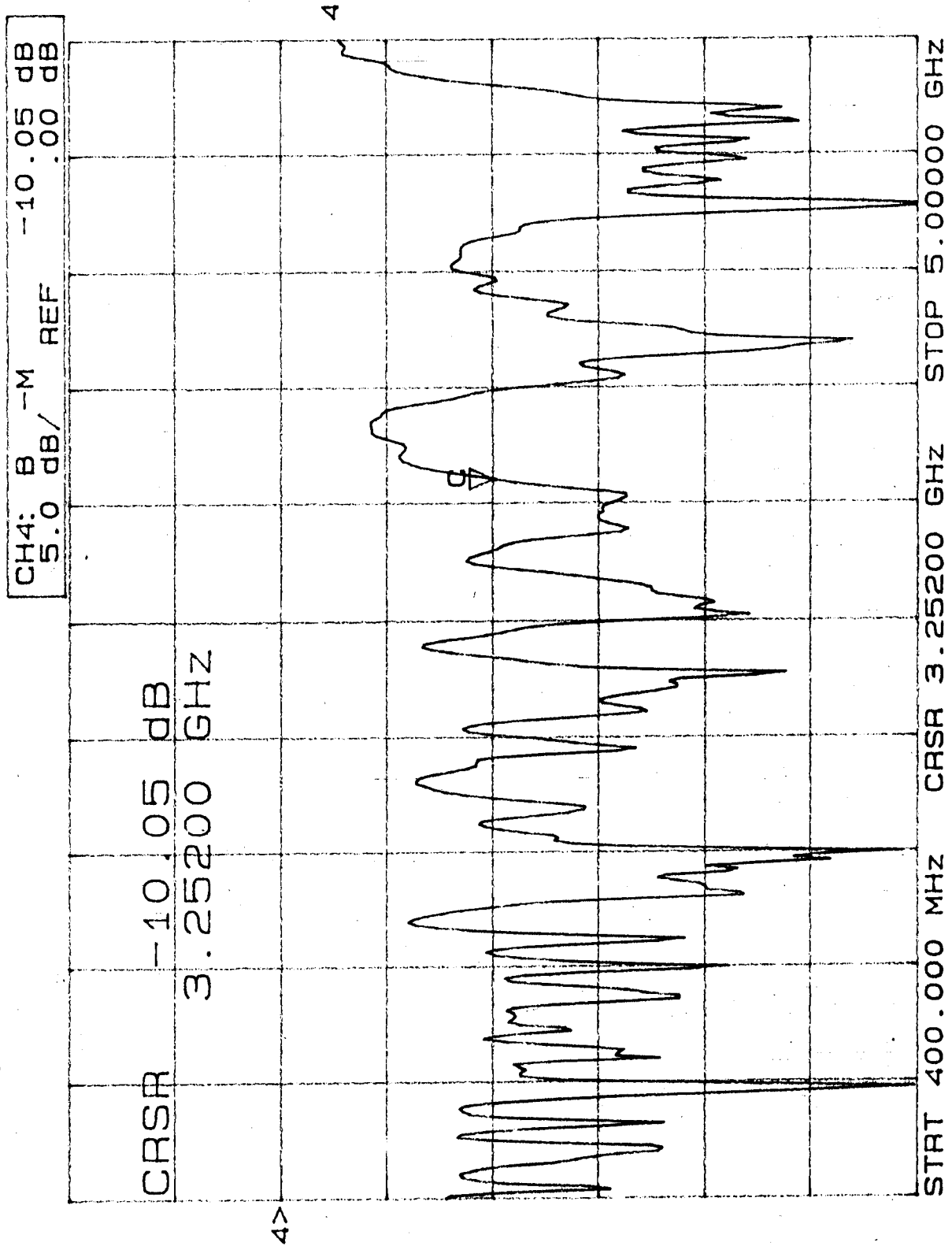

02 Apr 04 17:05:48

## ***CHAPTER 4***

---

### ***DEVELOPMENT OF THE TEST SYSTEM***



## 4.1 Development of Test Range for radiation pattern measurements

Generally the performance of an antenna is evaluated in the far-field region, since the pattern is independent of the distance. In a typical far field set up the transmitting antenna and the receiving antenna are separated by a certain distance. The three main important parameters considered in the measurement of outdoor test ranges are

1. Range Length
2. Receiver tower height
3. Transmit tower height.

The basic test range setup is as shown below

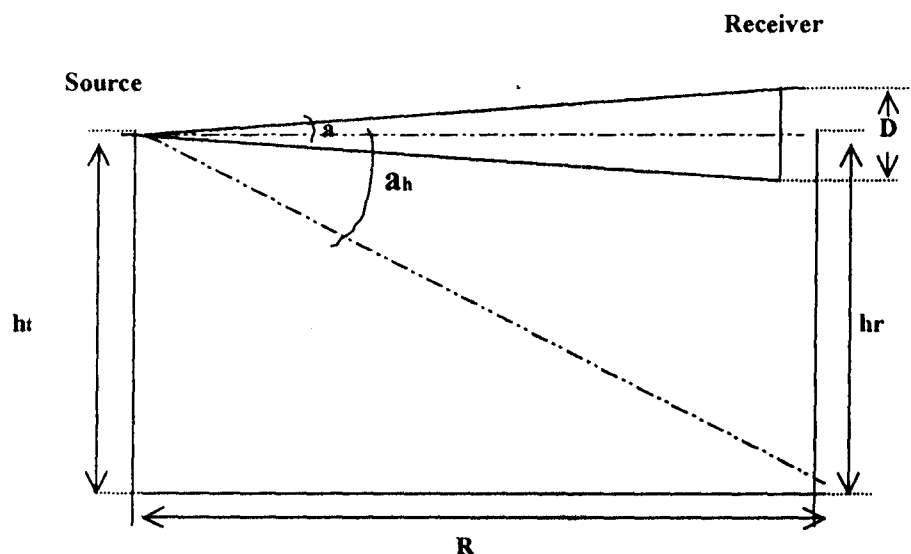

Fig. 4.1: Outdoor test range setup

### **Range Length**

The range length is the distance between the transmit and receiving antenna. It is normally greater than the far field distance of the transmitting antenna. If  $D$  is the maximum dimension of the transmitter, the range can be given by

$$R \geq 2D^2 / \lambda \quad \dots\dots\dots (4.1)$$

### Receiver Tower height

The height of the test antenna and hence that of the receiver tower, is the second parameter which should be determined. It is assumed that the source and the receiver are placed at the same height above the ground. Their distance above the ground ( $hr$ ) is normally kept at 4 times the diameter ( $D$ ) of the antenna to be tested. This will ensure the uniform illumination of the source antenna on the test antenna.

$$hr \geq 4D \quad \dots\dots\dots (4.2)$$

### Transmit Tower height

The height of the transmit antenna is placed at the same height as that of the test antenna.

## 4.2 The Test System

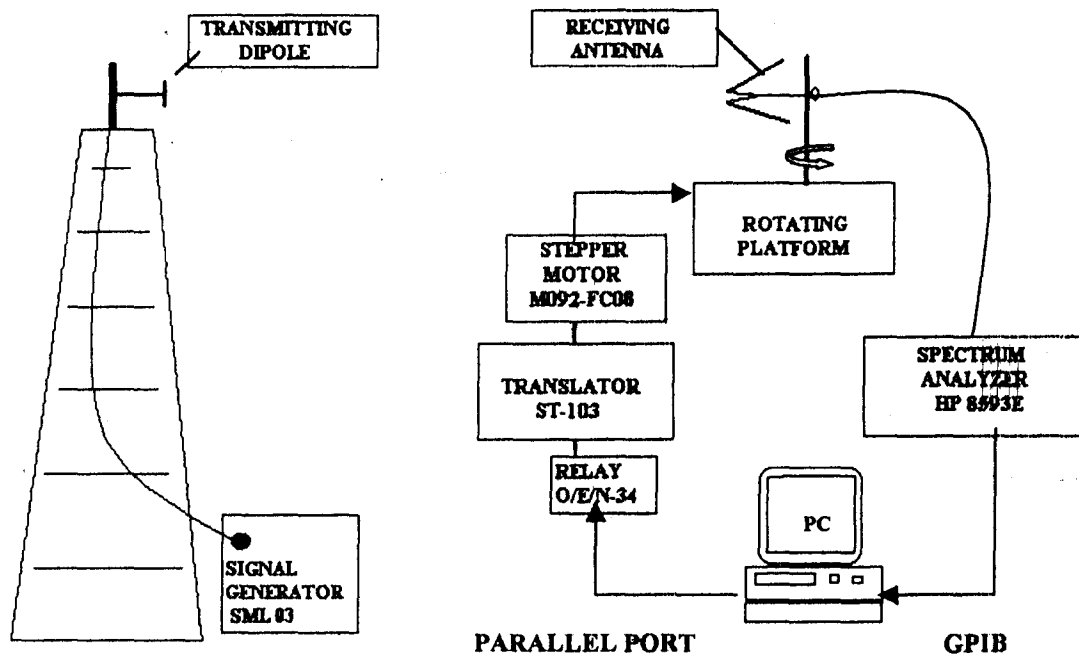
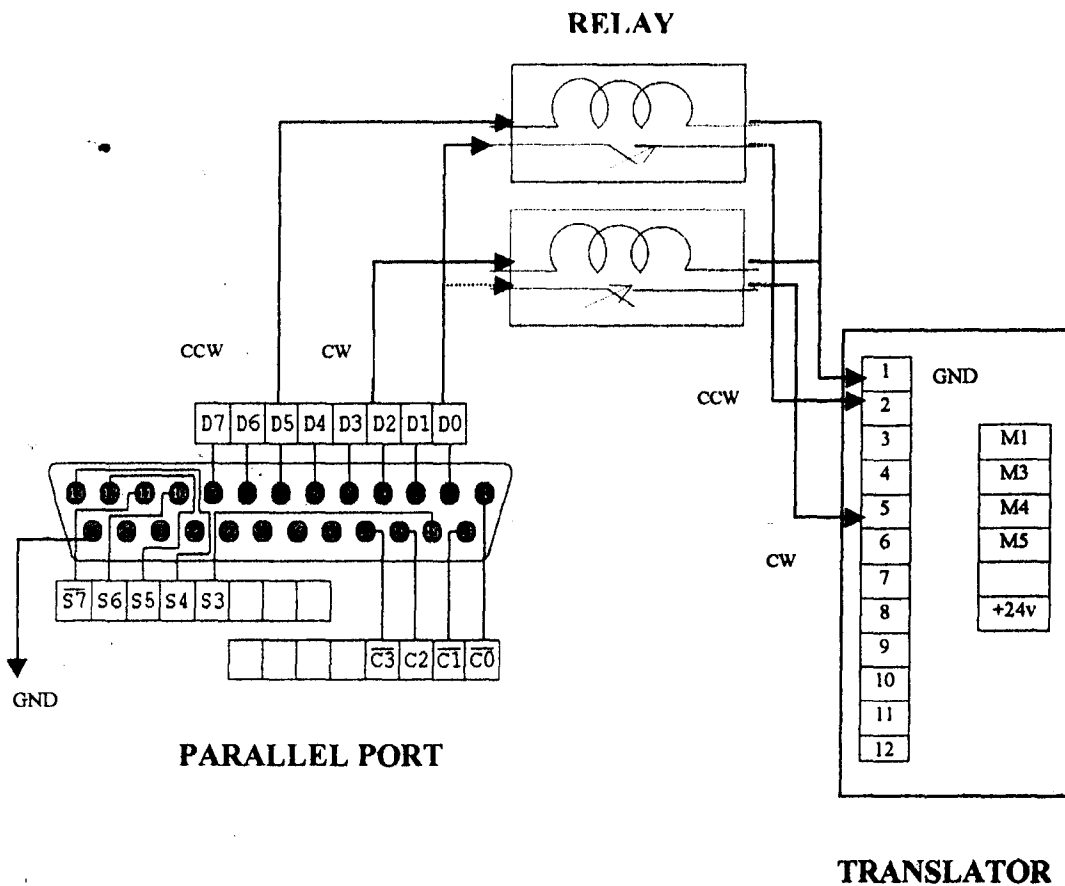

FIG 4.2: Basic Setup of the Test System

The test system is as shown in Fig. 4.2. The signal to be transmitted is generated by a frequency synthesizer connected to the transmitting antenna. The transmitting antenna is connected to the signal generator through a coaxial cable. The antenna used is an electric dipole antenna, tuned to the frequency 1GHz.

The Log- periodic trapezoidal antenna is placed at the far field distance of the transmitting dipole and connected to the spectrum analyzer through a coaxial cable. The spectrum analyzer is connected to the computer via the General Purpose Interface Bus. The computer generates the square pulses required for the translator to run. These pulses are fed into the translator through the relay device connected to it. The translator in turn rotates the antenna.

#### 4.2.1 Wiring Diagram



**Fig 4.3: Wiring Diagram showing the connection between Parallel Port, Relay and Translator**

Fig 4.3 shows the specific wiring diagram between the Parallel Port, Relay and the Translator. Two relays are used, one for clockwise rotation (CW) of the stepper motor and the other for counter-clockwise rotation (CCW).

### **4.3 SLO-SYN Translator**

The ST103 Translator is an enclosed unit containing the power supply and the logic elements needed for bi-directional control of a control of a SLO-SYN stepping motor. It can be operated in two basic modes namely, the Local mode and the Remote mode. In the local mode the triggering pulses are generated internally in the enclosed unit. In the remote mode the triggering pulses are fed into the translator through an external pulse generator. When operated from an external pulse source, the ST103 is triggered by a change in voltage from logic level 0 (0 to 0.4 VDC) to logic level 1 (2 VDC to 7VDC) at the respective terminals. Terminal 2 is used for a counter-clockwise rotation of the motor shaft and terminal 5 is used for clockwise rotation.

As was mentioned, the ST103 is used to run a DC stepper motor.

#### **4.3.1 SLO-SYN DC Stepping Motor**

A SLO-SYN stepping motor is a permanent magnet motor that converts electronic signals into mechanical motion. Each time the direction of current in the motor windings is changed, the motor output shaft rotates a specific angular distance.

The motion of the SLO-SYN stepping motor is controlled by the ST103 Translator. The motor is attached to the antenna mount. The movement of the motor in the required direction is selected on the translator. Upon the energizing of the motor, the antenna can be rotated in the required direction and also by the required angle. The translator can also control the speed of the motor.

### **4.4 The Parallel Port**

The Parallel Port is the most commonly used port for interfacing projects. This port will allow the input of up to 9 bits or the output of 12 bits at any one given time, thus requiring minimal external circuitry to implement many simpler tasks. The port is

composed of 4 control lines, 5 status lines and 8 data lines. It is commonly found on the back of the PC as a D-Type 25 Pin female connector.

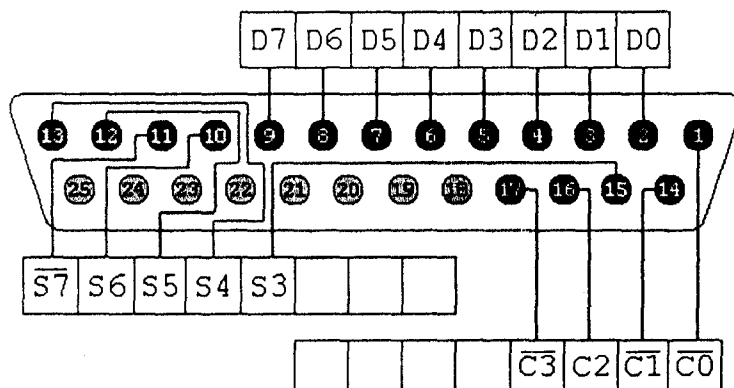

**Fig 4(d): 25-way Female D-Type Connector**

The output of the Parallel Port is normally TTL logic levels. The current you can sink and source varies from port to port.

Thus the parallel port is made use of to send out square pulses required to control the working of the ST103 Translator by the computer. Direction control is brought about through a Relay device.

## **4.5 The Relay**

A relay may be defined as electrically triggered contact maker or breaker. In our case, the relay is used to control the direction of motor rotation. There are two relays connected between the computer parallel port and the Translator. Depending upon our choice, the respective relay circuit is switched on and the computer generated square pulses are fed into the ST103 Translator.

Thus the motor is made to rotate by the required number of degrees, in steps. At every step the received signal strength is measured and displayed on a Spectrum Analyzer.

## **4.6 The Spectrum Analyzer**

The spectrum analyzer is an instrument, which displays the frequency spectrum and characteristics of an input signal. It can be used to view signals across a wide range of frequencies.

The Spectrum analyzer is connected to the test antenna. It is used to map the received signal strength. It is interfaced with the computer via a bus called the GPIB. The readings are recorded into the computer through this bus.

## **4.7 The GPIB**

The General Purpose Interface Bus (GPIB) is widely used for enabling test instruments to be controlled remotely. The GPIB is a very flexible system, allowing data to flow between any of the instruments on the bus. The bus has a total of sixteen active lines. These lines can be organized into three categories. Eight are used for data transfer, three are used for a comprehensive form of handshaking, and the remaining five are used for general bus management, carrying status and control information.

In our case, the GPIB acts as the interface between the spectrum analyzer and the computer. Received signal strength seen on the computer is noted on to the computer through the GPIB. Programming for data acquisition is done in the C code. The antenna is rotated in steps. And at every step, data is acquired and recorded on the computer. The recorded readings are then plotted using the MATLAB tool.

## **4.8 Software Algorithms**

Given below are the various software algorithms used in the Test System.

### **4.8.1 Generation Of Square pulses**

#### **INITIALIZATION:**

The Parallel Port Address is defined along with the address for data registers as data lines (D0-D8) are being used to send the control word.

**CONTROL WORD DEFINITION:**

The Control Words are chosen so as to toggle the D0 bit High and Low after a 10-millisecond delay while keeping the respective relays on.

The chosen Control Words are 0X05, 0X04, 0X21, 0X20 with the higher nibble for relay control and lower nibble for generating a square train with  $T_{ON}$  10 millisecond and  $T_{OFF}$  10 millisecond.

**FOR LOOP:**

The FOR loop is run 690 times as this is the required number of pulses to obtain a 5 degree rotation.

**4.8.2 Data Acquisition****INITIALIZATION:**

The IEEE 488.2 bus is scanned for the presence of the Spectrum Analyzer and is assigned the unique id **pmm**.

**QUERYING AND PROGRAMMING COMMANDS:**

The device is programmed to assign a marker for the peak value and is then sent the query to return the marker amplitude. The above step is repeated 10 times and the average value of the marker amplitude is stored in a variable called **numb**.

**STORING VALUES:**

A file pointer is assigned and the file is opened in append mode and the value of **numb** is written to the file.

**TERMINATION:**

Once the values are stored in the file the device is given the command to enable it to be programmed in local mode and is then taken offline.

**4.8.3 The Batch File**

The programs for generation of square waves and data acquisition are incorporated in a batch file. The program for square wave generation is written such that,

it rotates the antenna by an angle of  $5^\circ$ . Then data is to be acquired. Thus for one complete rotation of  $180^\circ$  the square wave program should be executed 36 times. And in between each execution, data is to be acquired. Hence the batch file is written such that, there are alternate executions of the program for square wave generation and data acquisition.

Thus the antenna is rotated in steps by an angle of  $5^\circ$  and consequently data acquired. The received data is stored in a Notepad Text file. After this is repeated for both planes of polarization, the corresponding readings are overlapped using a MATLAB program.

#### **4.8.4 Plotting of Radiation Pattern**

##### **INITIALIZATION:**

The x- axis value is set to show a variation between  $-90^\circ$  to  $+90^\circ$ . The y-axis is a measure of the received signal strength.

##### **TEXT FILES:**

The corresponding Text files, for the orthogonal planes of polarization are loaded.

##### **PLOTTING AND DISPLAY:**

The values stored in the Text files are plotted in different colours to represent the two planes of polarization. The plotted values are displayed on the grid.



## ***CHAPTER 5***

---

### ***RESULTS AND CONCLUSION***

## **5.1 Measurement Of Readings**

The experiment was setup as mentioned in the previous chapter. The signal generator was set to a particular frequency at which the test antenna had to be characterized. The receiving antenna was rotated in the azimuth at steps of  $5^\circ$ . Output of the test antenna measured by the spectrum analyzer was recorded by the computer. The above procedure was repeated over an azimuth angle range of  $+90^\circ$  and  $-90^\circ$ . The recorded data was plotted as a function of the azimuth angle to get the radiation pattern of the test antenna. The same procedure was adopted to get the radiation patterns in both E and H planes at different frequencies. Care was taken that to ensure that the transmitting and receiving antenna were in the co-polar plane.

The experiment was repeated by modifying the structure of the receiving antenna to investigate the effect of various design parameters on the performance of the antenna. The radiation patterns obtained at different frequencies for various structural modifications are presented below.

**MODIFICATION 1:** The initial setup included metallic strips that held the connector of the antenna (Refer Figure 5.1). The radiation patterns plotted for this setup at various frequencies are presented in section 5.1(a).

**MODIFICATION 2:** The metallic strips were replaced by non-metallic strips. (Refer Figure 5.2). The radiation patterns plotted for this setup at various frequencies are presented in section 5.1(b).

**MODIFICATION 3:** Maintaining the above setup, the included angle  $\Psi$  between the two planes of the trapezoidal structure was altered to  $50^\circ$  from  $60^\circ$ . The radiation patterns plotted for this setup at various frequencies are presented in section 5.1(c).

**MODIFICATION 4:** The above exercise was carried out for an included angle of  $70^\circ$ . The radiation patterns plotted for this setup at various frequencies are presented in section 5.1(d).

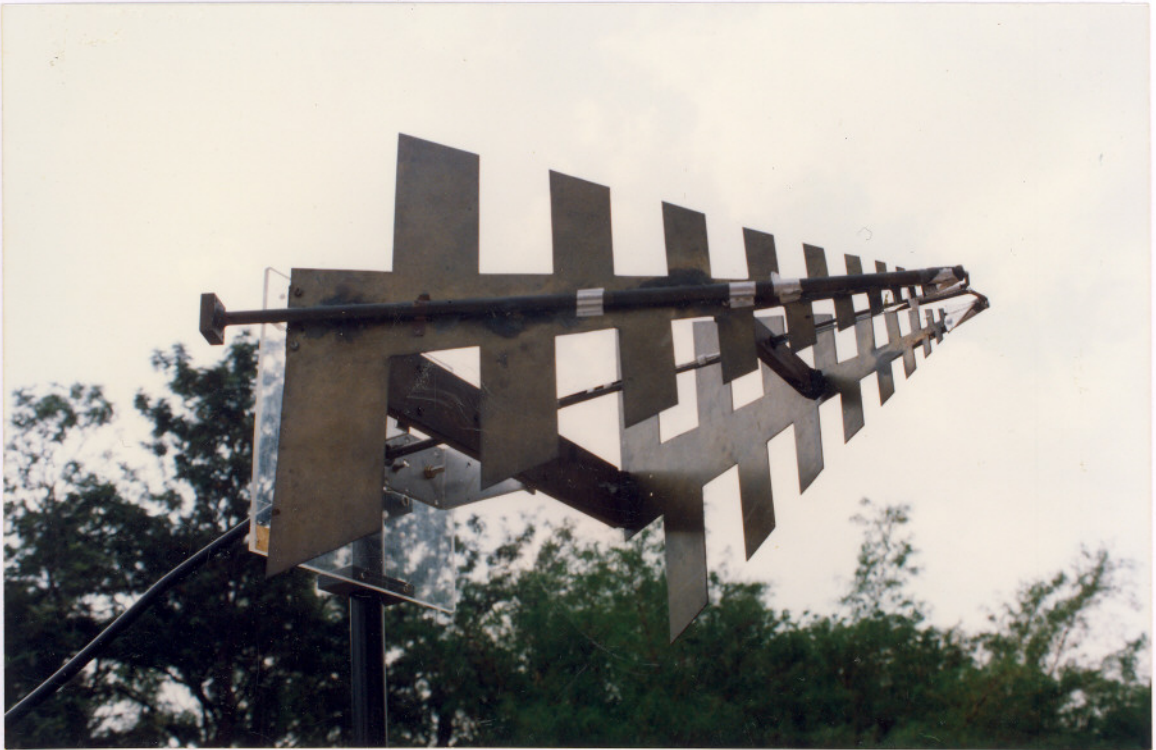

**Fig 5.1: Antenna with metallic strips (Modification 1)**

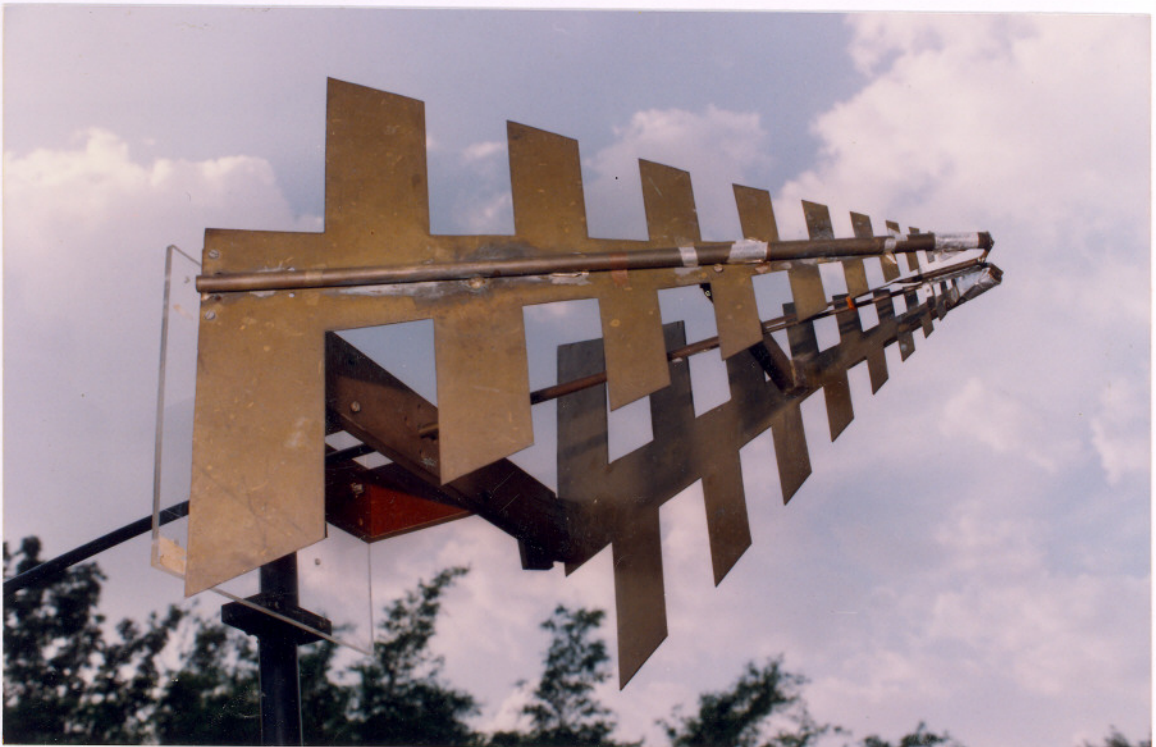

**Fig 5.2: Antenna with non-metallic strips (Modification 2)**

**5.1(a) RADIATION PATTERNS FOR MODIFICATION 1 :**

**Frequency :  
800 MHz**

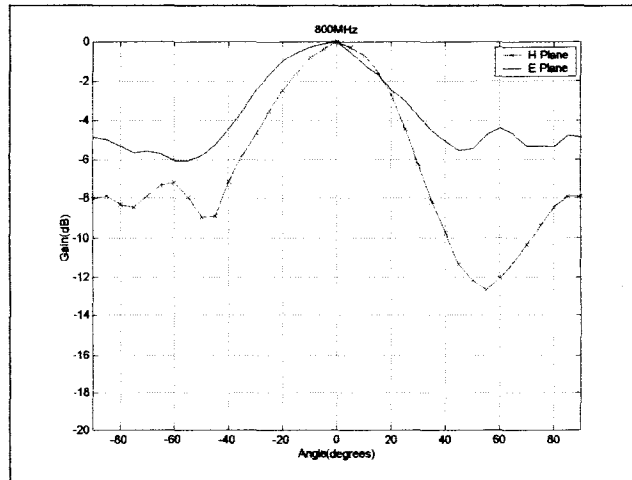

**Frequency :  
1000 MHz**

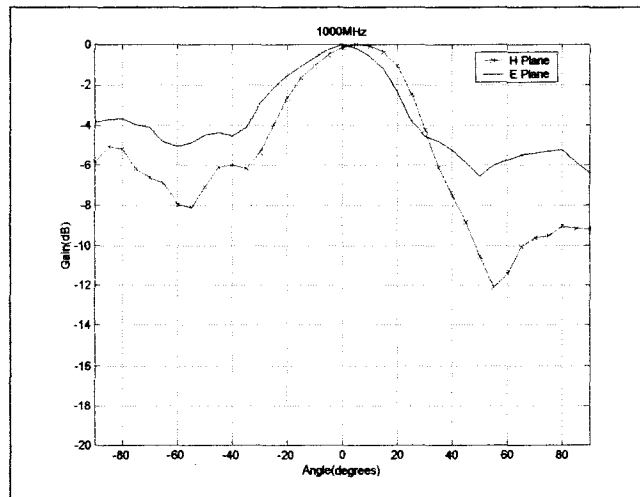

**Frequency :  
1200 MHz**

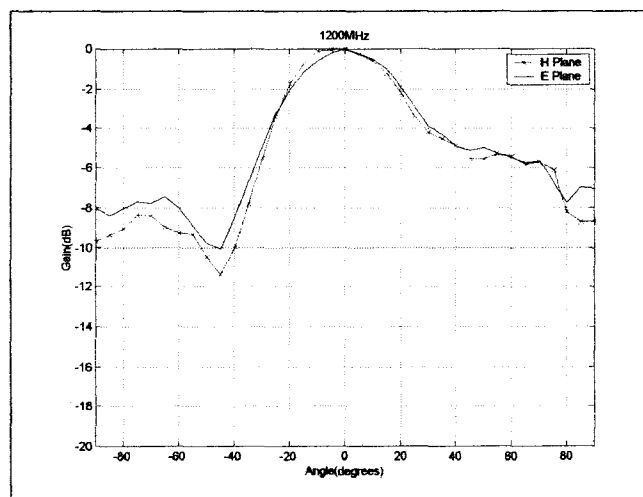

**E plane — Continuous  
H plane — Dotted**

**Frequency :  
1400 MHz**

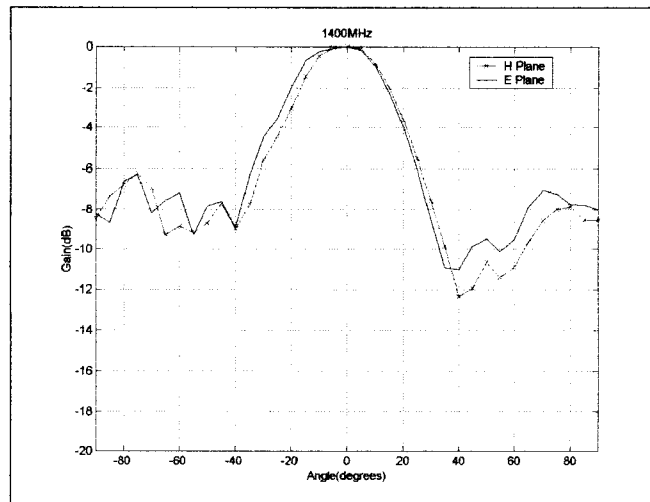

**Frequency :  
1500 MHz**

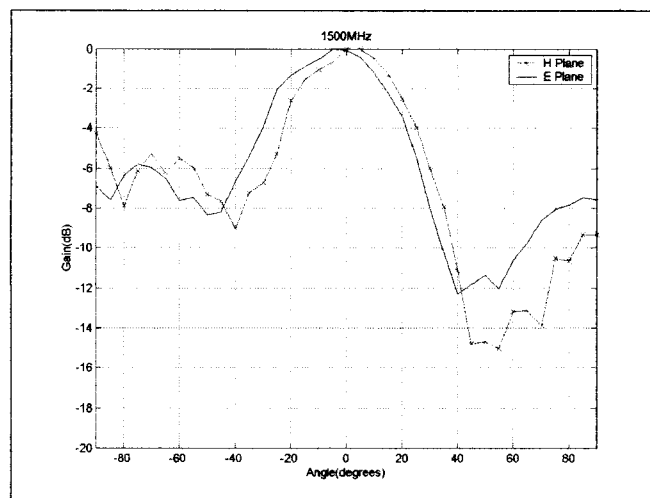

**Frequency :  
1600 MHz**

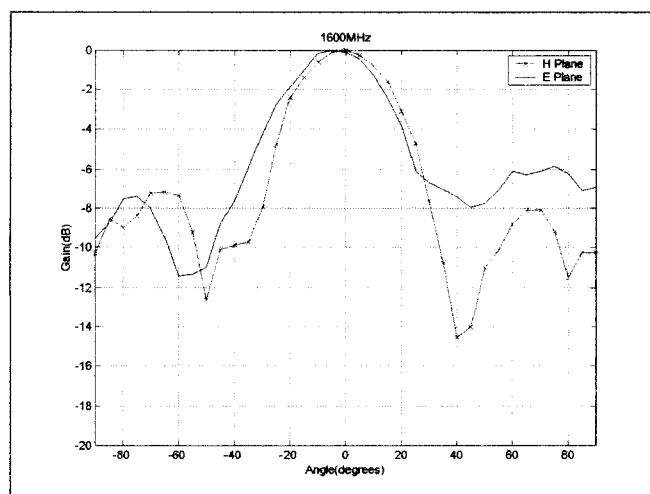

**E plane --- Continuous  
H plane --- Dotted**

**5.1(b) RADIATION PATTERNS FOR MODIFICATION 2 :**

**Frequency :  
800 MHz**

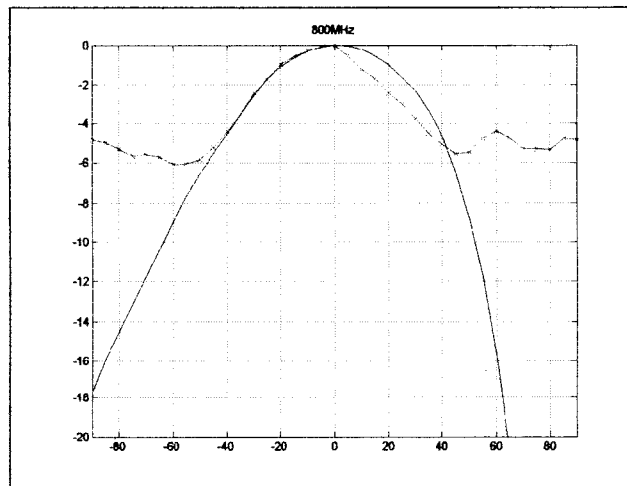

**Frequency :  
1000 MHz**

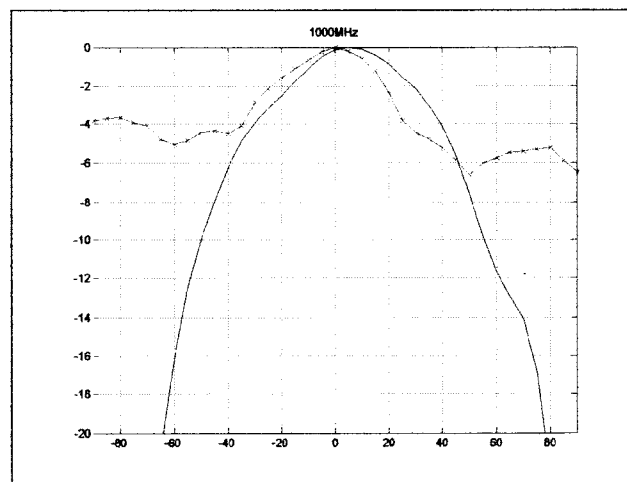

**Frequency :  
1200 MHz**

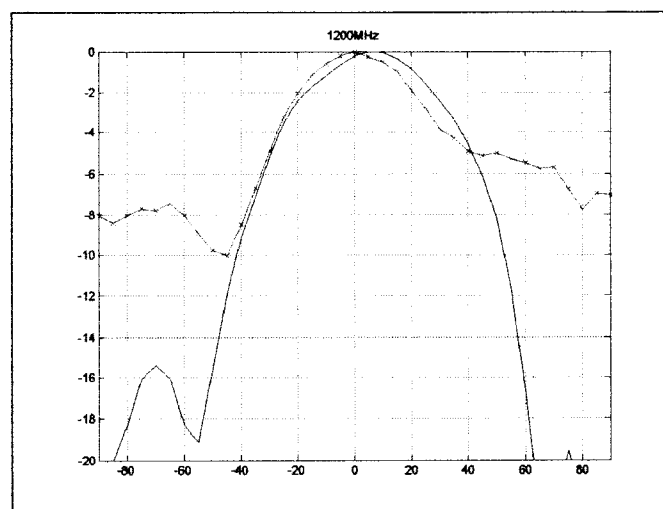

**E plane --- Continuous  
H plane --- Dotted**

**Frequency :  
1400 MHz**

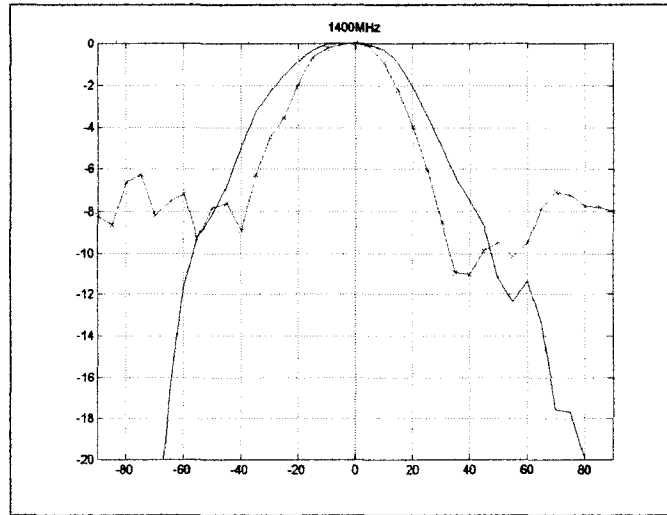

**Frequency :  
1500 MHz**

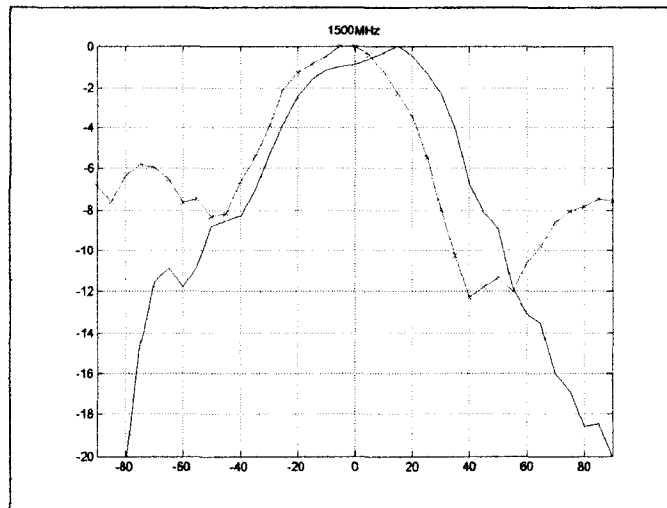

**Frequency :  
1600 MHz**

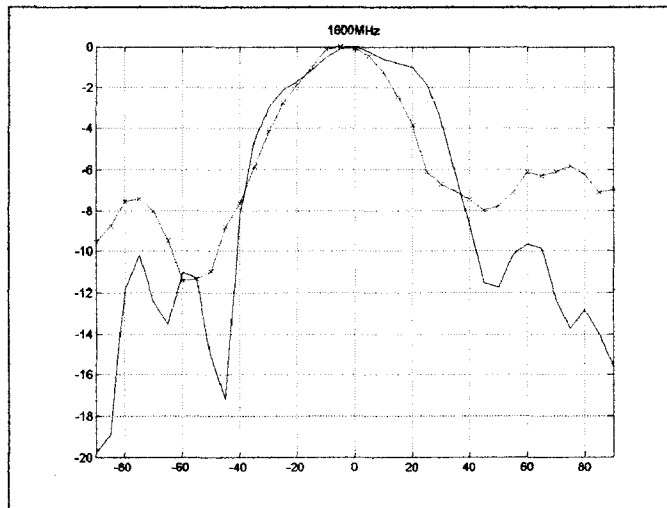

**E plane --- Continuous  
H plane --- Dotted**

**5.1(c) RADIATION PATTERNS FOR MODIFICATION 3 :**

**Frequency :  
800 MHz**

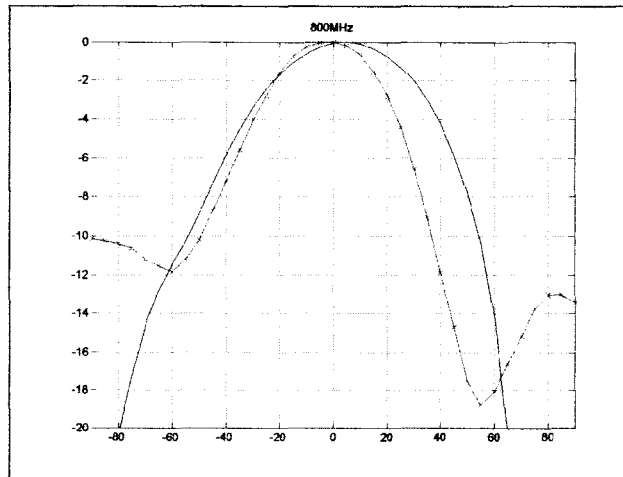

**Frequency :  
1000 MHz**

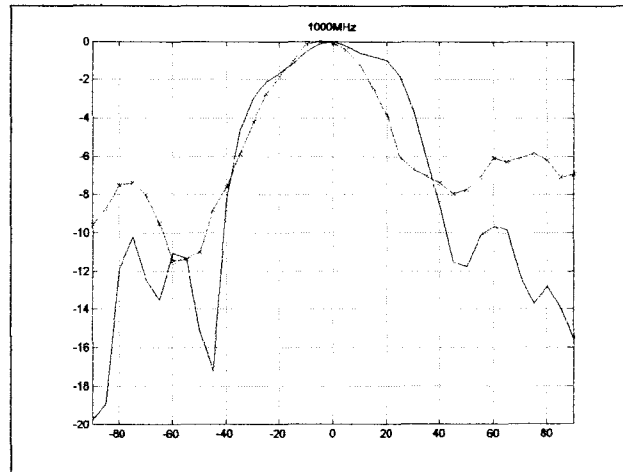

**Frequency :  
1200 MHz**

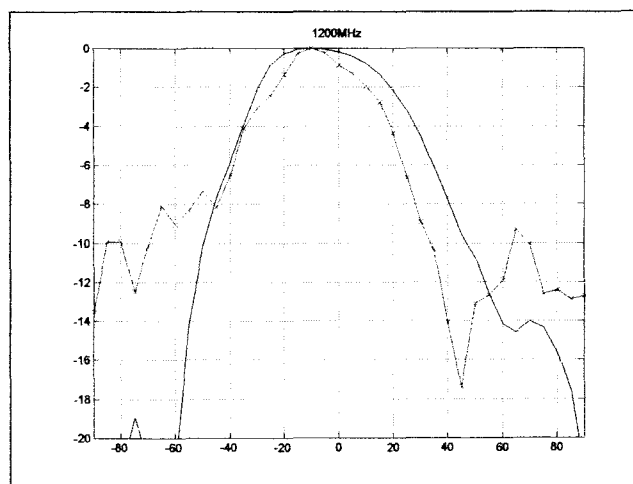

**E plane --- Continuous  
H plane --- Dotted**



**Frequency :  
1400 MHz**

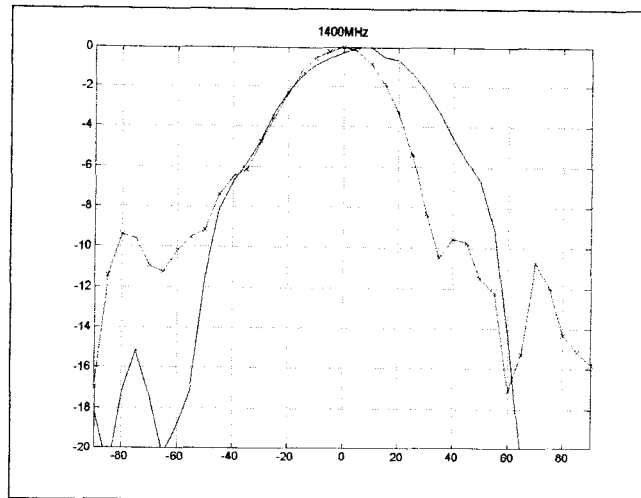

**Frequency :  
1500 MHz**

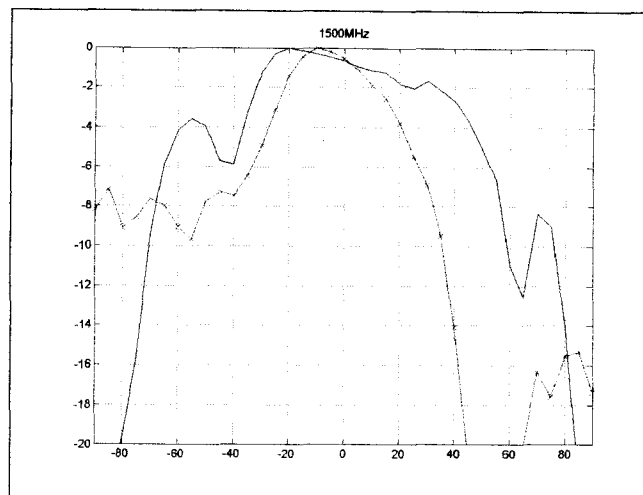

**Frequency :  
1600 MHz**

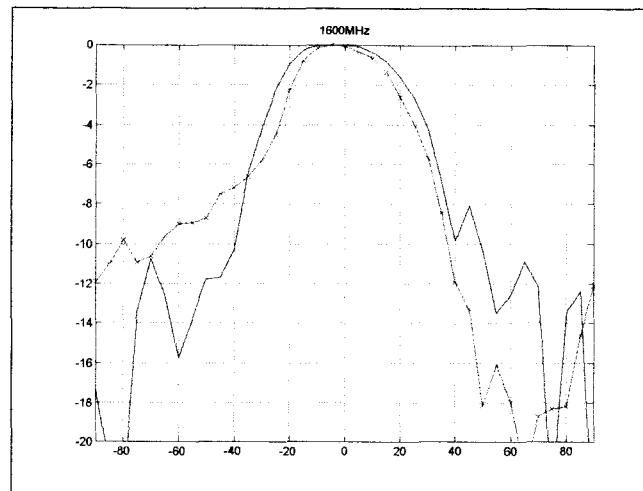

**E plane --- Continuous  
H plane — Dotted**

**5.1(d) RADIATION PATTERNS FOR MODIFICATION 3 :**

**Frequency :  
800 MHz**

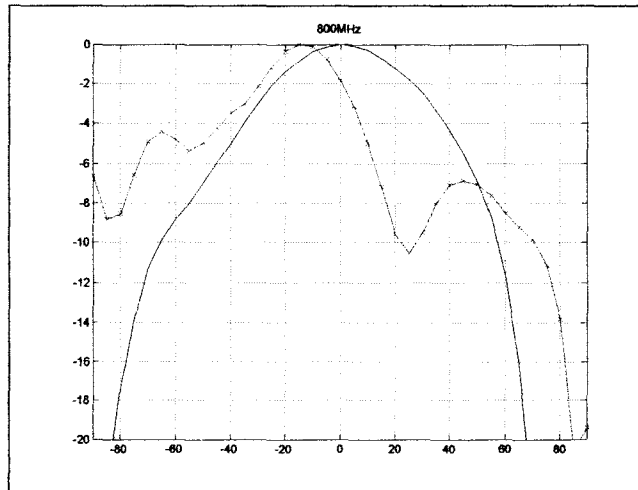

**Frequency :  
1000 MHz**

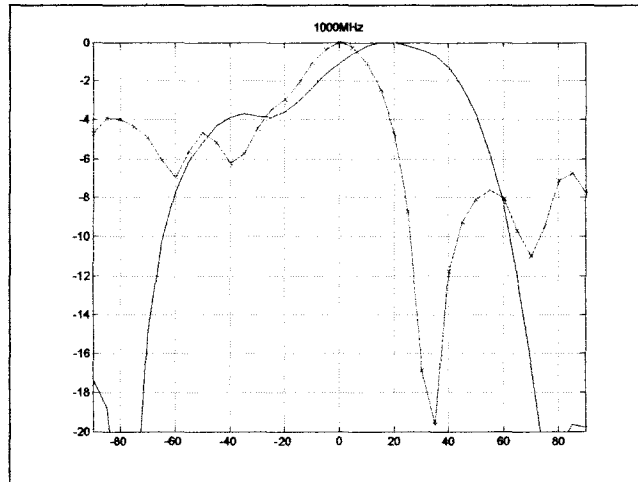

**Frequency :  
1200 MHz**

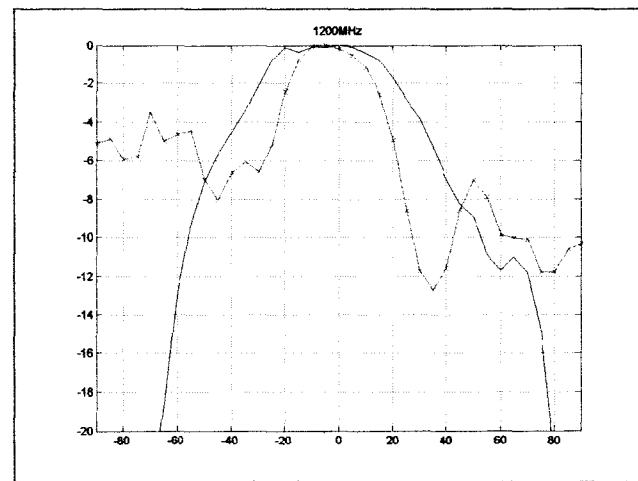

**E plane --- Continuous  
H plane --- Dotted**

**Frequency :  
1400 MHz**

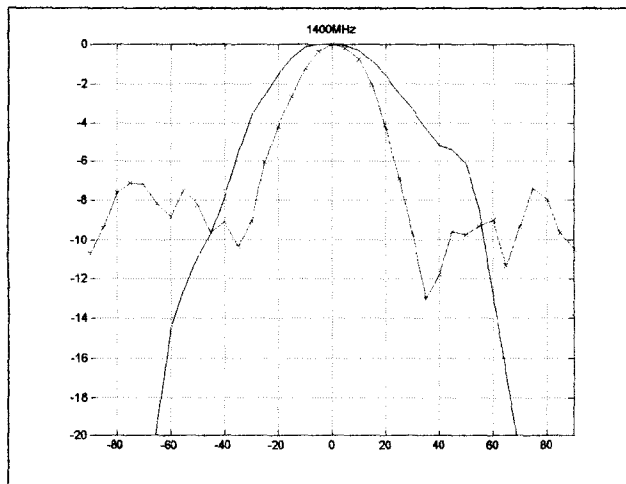

**Frequency :  
1500 MHz**

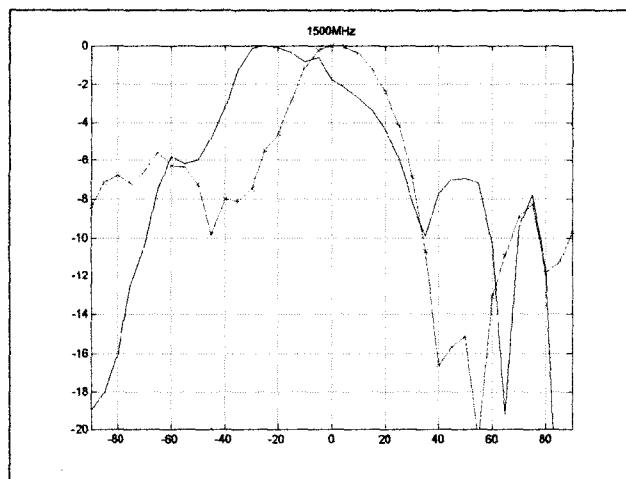

**Frequency :  
1600 MHz**

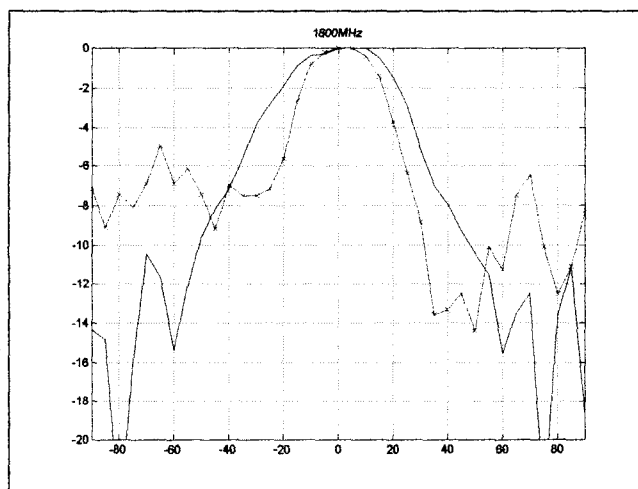

**E plane --- Continuous  
H plane --- Dotted**

## **5.2 CONCLUSION AND SCOPE FOR FURTHER DEVELOPMENT**

We have successfully studied the effect of various design parameters on the performance of the trapezoidal structure. Our characterization was restricted to the frequency range of 0.5GHz to 1.5GHz, because of non-availability of transmitting antenna at high frequencies during the time of our experimentation. Our results indicate that the trapezoidal structure can be made use of as a multi –octave prime focus feed, if proper care is taken while designing the mechanical structure of the antenna.

There is large scope for improving the performance of the antenna over the frequency range as high as 0.5GHz to 5 GHz.

## ***APPENDIX***

---

## C PROGRAM FOR COUNTER-CLOCKWISE CONTROL OF THE MOTOR

```
#include<stdio.h>
#include<dos.h>
#include<time.h>
#define PORTADR 0X378
#define DATAHI 0X21
#define DATALO 0X20
#define PORTADDRESS PORTADR+0
void main()
{
    int i;
    for(i=0;i<690;i++)
    {
        outportb(PORTADDRESS,DATAHI);
        delay(1);
        outportb(PORTADDRESS,DATALO);
        delay(1);
    }
}
```

## C PROGRAM FOR CLOCKWISE CONTROL OF THE MOTOR

```
#include<stdio.h>
#include<dos.h>
#include<time.h>
#define PORTADR 0X378
#define DATAHI 0X05
#define DATALO 0X04
#define PORTADDRESS PORTADR+0
void main()
{
    int i;
    for(i=0;i<690;i++)
    {
        outportb(PORTADDRESS,DATAHI);
        delay(1);
        outportb(PORTADDRESS,DATALO);
        delay(1);
    }
}
```

## C PROGRAM FOR DATA ACQUISITION

```
/* Communication with the spectrum analyzer */
#include <stdio.h>
#include <stdlib.h>
#include <dos.h>
#include <windows.h>
#include <time.h>
#include <process.h>
#include "decl-32.h"
#include <errno.h>
FILE *fp1;          /*filepointer for data34.txt*/
void main()
{
    int a,pmm ,j;    /* file descriptor for spectrum analyzer */
    int i;           /* loop control variable */
    char reading[30]; /* stores measurement readings from pmm*/
    float f;
    float num, numb;
    fp1=fopen("data34.txt","a");
    pmm = ibdev(0, 13, 0, T10s, 1, 0) ;
    num=0.0 ;
    for (i=0; i <10; i++)
    {
        /* Request voltage reading from pmm */
        ibwrt(pmm, "mkpk HI \r\n", 10L);
        ibwrt(pmm, "mka?", 4L);
        /* Read data from pmm */
        ibrd(pmm, reading, 20L) ;
        /* Null terminate the string */
        f = atof(reading);
        num = f + num;
    }
    numb = num/i ;
    i=num=0 ;
    ibwrt(pmm,"conts\r\n",9L);
    fprintf(fp1,"%f\n",numb);
    fclose(fp1);
    ibloc(pmm);
    ibonl(pmm, 0) ;
}
```

## MATLAB PROGRAM FOR THE PLOTTING OF RADIATION PATTERN

```
%run f:\be_2004\Plot.m
%load('c:\bc\data34.txt');
theta=-90;
for i=1:37
    data(i,1)=theta;
    theta=theta+5;
end

data(:,2)=load('f:\be_2004\800hplane.txt');
data(:,3)=load('f:\be_2004\800hplane.txt');
max(data(:,[2 3]))
plot((data(:,1)), -1*(max(data(:,2))-(data(:,2))), 'r');
hold on
plot(data(:,1), -1*(max(data(:,3))-(data(:,3))), 'b');
grid on;
```

## MATLAB PROGRAM FOR THE COMPARISON OF RADIATION PATTERNS

```
%run f:\be_2004\Compare.m
%load('c:\bc45\data34.txt');
theta=-90;
for i=1:37
    data(i,1)=theta;
    theta=theta+5;
end

data(:,2)=load('f:\be_2004\50hplane\800hplane.txt');
data(:,3)=load('f:\be_2004\50eplane\800eplane.txt');
max(data(:,[2 3]))
plot((data(:,1)), -1*(max(data(:,2))-(data(:,2))), 'r');
hold on
plot(data(:,1), -1*(max(data(:,3))-(data(:,3))), 'b');
grid on;
```



**INSTRUCTIONS**  
for  
**INSTALLATION, OPERATION**  
and **MAINTENANCE**

**SLO-SYN®**  
**TRANSLATOR**  
**TYPE ST103**

**CAUTION**

Since this product will be used in applications beyond the control of The Superior Electric Company, the system designer is advised to incorporate protection features which will insure user and equipment safety.

**INSPECTION**

When unpacking the SLO-SYN Translator, examine it carefully for any shipping damage. The "Damage and Shortage" instruction packed with the unit outlines the proper procedure to follow if any parts are damaged or missing.

**DESCRIPTION**

The ST103 is an enclosed unit containing the power supply and logic elements needed for bidirectional control of a SLO-SYN stepping motor. Triggering pulses can be supplied by the internal oscillator or by an external pulse source and the translator will drive the motor one step for each pulse received. The motor can be driven in the half-step mode which provides a 0.9° step increment or in the full-step mode which gives a step increment of 1.8°. The ST103 can be mounted on any horizontal surface and can also be mounted in a standard 19" relay rack.

**TEMPERATURE**

The ST103 SLO-SYN Translator can be operated in ambient temperatures from 0°C to +40°C. It can be stored in ambient temperatures from -55°C to +85°C.

**TRIGGERING REQUIREMENTS**

When operated from an external pulse source, the ST103 is triggered by a change in voltage from logic level 0 (0 to 0.4 VDC) to logic level 1 (2.0 VDC to 7.0 VDC) at terminal 6 for clockwise motor shaft rotation or at terminal 2 for counter-clockwise rotation. A diagram showing a typical triggering pulse waveform is provided. Direction of motor shaft rotation is referenced facing the nameplate end of the motor.

Complete triggering signal requirements are as follows:

Logic 1 Level .....	2.0 VDC to 7.0 VDC
Logic 0 Level .....	0 to 0.4 VDC
Minimum Pulse Width .....	10 microseconds
Maximum Rise Time .....	1 microsecond
Maximum Fall Time .....	1 microsecond
Loading .....	1.6 mA maximum
Trigger Edge .....	logic 0 to logic 1 transition

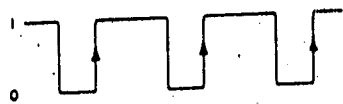

TYPICAL TRIGGERING PULSE WAVEFORM



**THE SUPERIOR ELECTRIC COMPANY**  
Bristol, Connecticut 06010

## MOUNTING

The ST103 SLO-SYN Translator is designed to stand on a bench, shelf or other horizontal surface. Keep the area under the unit and the area by the fan outlet clear to allow proper flow of cooling air.

The ST103 can also be mounted in a standard 19" rack, but a shelf or support must be provided for the back of the unit. If necessary, the feet can be removed from the cabinet and the cabinet can then be fastened in place using the #8-32 tapped holes thus provided. The Mounting Dimension drawing shows mounting hole locations and other critical dimensions. Provisions must be made to insure sufficient flow of cooling air up through the bottom of the unit.

## ELECTRICAL INSTALLATION

A 12-terminal plug-in connector and a 6-terminal barrier strip are located on the back of the translator for making the connections to the external control functions. Specific instructions for each phase of the external connections follow:

### Motor Connections

Motor connections to the ST103 translator are made to the 6-terminal barrier strip on the back of the unit. Be sure dropping resistors of the correct value are installed in the two common motor leads. Ratings of the dropping resistors required for each motor are given in the Dropping Resistor chart. Impedance of the motor leads must not exceed 80 milliohms (equivalent to 20 feet of #16 wire). If longer leads are required, a larger wire size must be used so that impedance will not exceed 80 milliohms.

If necessary, the rotation of the motor in the plus and minus directions can be reversed by reversing the motor lead connections at terminals M4 and M5.

DROPPING RESISTORS

MOTOR	STEP INCREMENT		DROPPING RESISTOR (2 REQUIRED)	
	HALF-STEP MODE	FULL-STEP MODE	RATING	PART NUMBER
M061-FC08 M061-FD08	0.9°	1.8°	6 ohm $\pm$ 5% 100 watt	DR103788-G9
M062-FC09 M062-FD09	0.9°	1.8°	4.5 ohm $\pm$ 5% 160 watt	BM133832-G6
M063-FC09 M063-FD09	0.9°	1.8°	4.5 ohm $\pm$ 5% 160 watt	BM133832-G6
M091-FC09 M091-FD09	0.9°	1.8°	4.5 ohm $\pm$ 5% 160 watt	BM133832-G6
M092-FC09 M092-FD09	0.9°	1.8°	4.5 ohm $\pm$ 5% 160 watt	BM133832-G6
M093-FC11 M093-FD11	0.9°	1.8°	4 ohm $\pm$ 5% 160 watt	BM133832-G9
M111-FD12	0.9°	1.8°	4.5 ohm $\pm$ 5% 160 watt	BM133832-G6
M112-FD12 M112-FJ12	0.9°	1.8°	4 ohm $\pm$ 5% 160 watt	BM133832-G9

### Stepping Mode Switches (HALF-STEP, 2 WINDINGS ON)

Single-pole, two-position switches or permanent connections are required for these functions. Connect the HALF-STEP switch between terminals 1 and 10 on the 12 terminal barrier strip and connect the 2 WINDINGS ON switch between terminals 1 and 9.

Closing the HALF-STEP switch will cause the translator to drive the motor in the half-step mode. When the 2 WINDINGS ON switch is closed, the motor will be driven in the full-step mode with two motor windings energized at all times. If both switches are open, the motor will be driven in the full-step mode with one winding on. A complete description of these operating modes is given in the Operation section of these instructions.

The HALF-STEP and 2 WINDINGS ON functions can also be controlled with voltages as described in the Electronic Control section of the Electrical Installation instructions.

### RUN and HI SPEED Switches

These functions also require single-pole, two-position switches. The RUN switch connects between terminals 1 and 4 and the HI SPEED switch between terminals 1 and 3. When operating the system from the internal oscillator, actuating the RUN switch will cause the translator to begin driving the motor at the base speed. Closing the HI SPEED switch will cause the translator to ramp the motor from the base speed up to the high speed.

The RUN and HI SPEED functions can also be operated using voltage levels. Refer to the Electronic Control section of the Electrical Installation instructions for details.

### JOG and JOG DIR Switches

The Jog function requires a single-pole, two-position switch and a single-pole, three-position switch is needed for Jog Dir control. The Jog Dir switch should be in the CW or CCW position if jog motion is needed or in the Off position if the Jog mode is not to be used. When the Jog Dir switch is at CW or CCW, the translator will drive the motor one step in the appropriate direction each time the Jog switch is closed.

### DIRECTION Switch

Direction control for operation from the internal oscillator requires a single-pole, three-position switch. Wiring for this switch is shown in the external connection diagram, Figure 1.

Directional control can also be done with voltage levels as described in the Electronic Control section of the Electrical Installation instructions.

### External Pulse Input

The external connection diagram shows the input channels for triggering the translator with pulses from an external source. Pulses must meet the specifications given in the "Triggering Requirement" section.

**Electronic Control**

HALF-STEP, 2 WINDINGS ON, RUN and HI SPEED can be controlled with voltage levels using the circuit shown in Figure 2. When a logic 1 level ( 2.0 VDC to 10VDC ) is applied to point A of this circuit, the appropriate function will be activated. The function will be deactivated when the voltage at point A returns to logic 0 ( 0 to 0.75VDC ).

DIRECTION control can be done using the circuit given in Figure 3. Applying a logic level 0 ( 0 to 0.5 VDC ) at points C and D will result in an off (no motion) condition. Applying a logic level 1 ( 2.0 VDC to 5.25 VDC ) at point C for clockwise motion or at point D for counterclockwise motion will cause the translator to drive the motor in the appropriate direction when the RUN function is activated. A logic level 1 must not be applied to points C and D simultaneously.

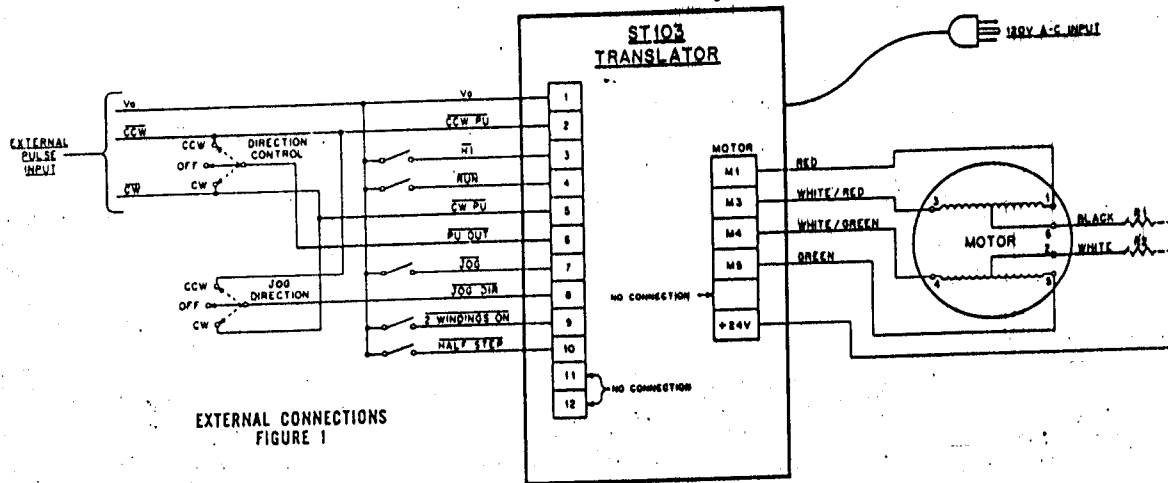

EXTERNAL CONNECTIONS  
FIGURE 1

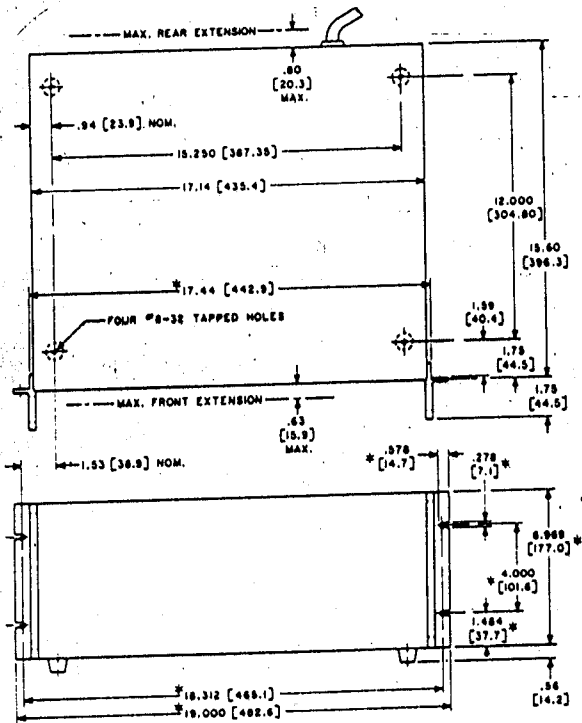

\* CONFORMS TO E.I.A. (ANSI C83.9-1972)  
STANDARDS FOR RACK MOUNTED EQUIPMENT

MOUNTING DIMENSIONS

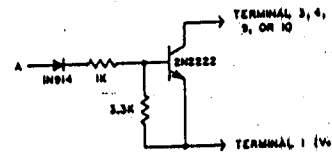

CIRCUIT FOR VOLTAGE LEVEL  
CONTROL OF HALF-STEP,  
2 WINDINGS ON,  
RUN AND HIGH SPEED  
FIGURE 2

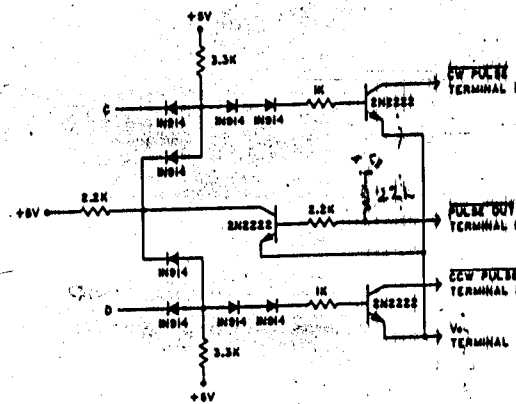

CIRCUIT FOR VOLTAGE LEVEL  
CONTROL OF DIRECTION  
FIGURE 3

**SPEED**

The curves show the speed vs torque characteristics for all applicable motors when driven by ST103 translator. Characteristics are shown for operation in the half-step mode and in the full-step mode with two windings on. When operated in the full-step with one winding on mode, torque will be 60% to 70% of that provided in the full-step, two windings on mode.

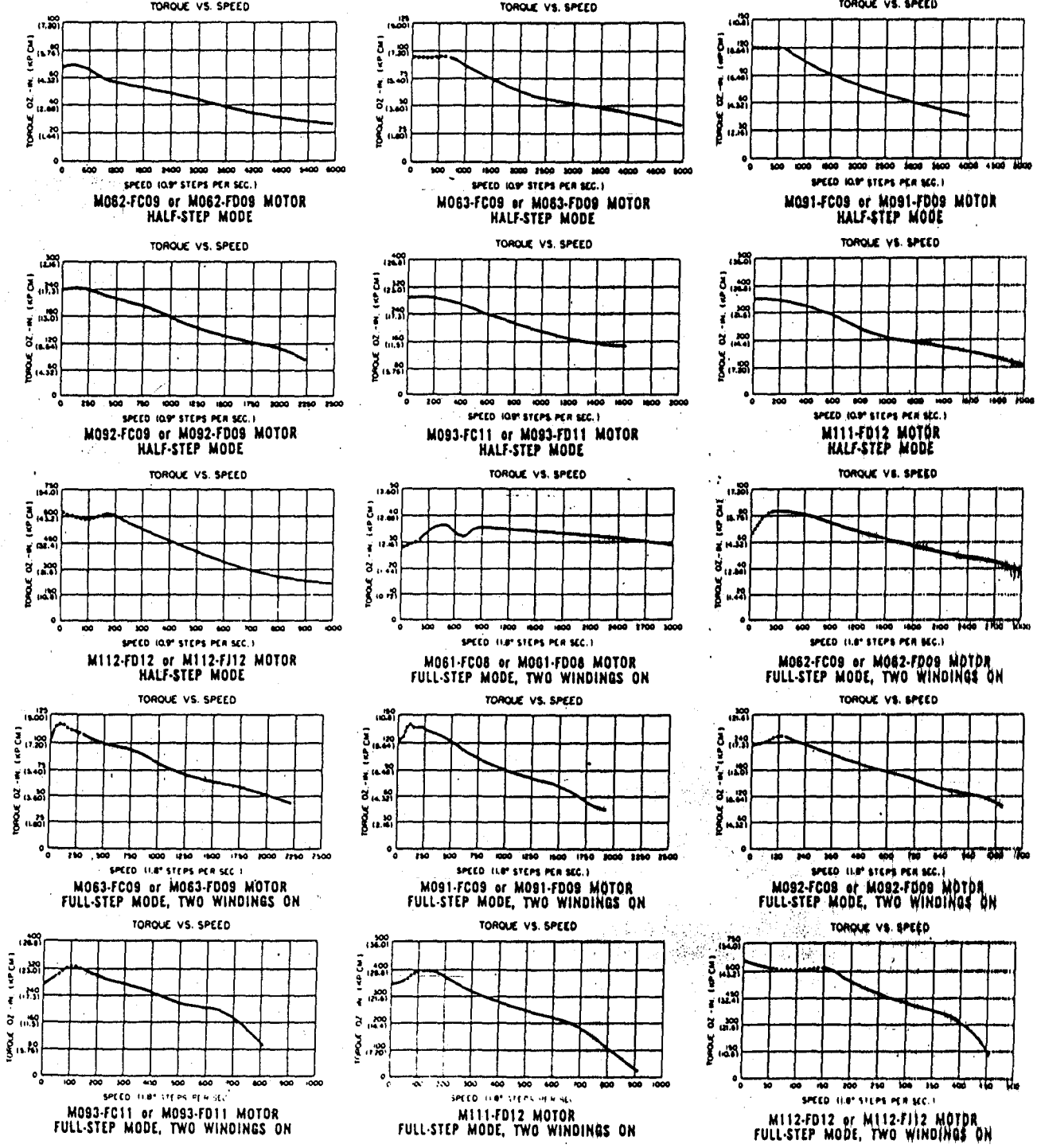

When operating from the internal oscillator, the translator will automatically accelerate and decelerate the motor to and from these speeds to prevent the motor from missing steps. Ramping of the pulse rate may also be necessary when the translator is operated from pulses supplied by an external source.

The part of each curve represented with a dotted line is an area of possible motor resonance. Depending on the load driven, the motor may not operate satisfactorily at the speeds shown in the dotted area. If poor performance is experienced at these speeds, the stepping rate should be increased to avoid the area of possible resonance. Adding an inertial load will also lower the frequency at which the resonance occurs.

**OPERATION**

**Operating Modes**

The ST103 SLO-SYN Translator can be operated in any of three modes: full-step with two windings on; full-step with one winding on; and half-step. A description of each mode follows:

**Full-Step, Two Windings On**

In this mode, the translator applies power to two motor windings at all times and drives the motor in 1.8° step increments. The motor windings are energized in the following sequence for clockwise motor rotation.

FULL-STEP, TWO WINDINGS ON

SWITCHING STEP	MOTOR LEAD OR TERMINAL			
	RED (1)	WHITE/RED (3)	WHITE/GREEN (4)	GREEN (5)
1	ON	OFF	OFF	ON
2	ON	OFF	ON	OFF
3	OFF	ON	ON	OFF
4	OFF	ON	OFF	ON
5	ON	OFF	OFF	ON

† Provides clockwise shaft rotation as viewed from nameplate end of motor. For counterclockwise rotation, switching steps will be performed in the reverse order.

The translator will be in the Full-Step, Two Windings On mode when the 2 WINDINGS ON switch is closed and the HALF-STEP switch is open.

**Full-Step, One Winding On**

This mode also drives the motor in steps of 1.8°, but only one motor winding at a time is energized. The following chart shows the sequence in which the motor windings are energized for clockwise motor rotation.

FULL-STEP, ONE WINDING ON

SWITCHING STEP	MOTOR LEAD OR TERMINAL			
	RED (1)	WHITE/RED (3)	WHITE/GREEN (4)	GREEN (5)
1	OFF	OFF	OFF	ON
2	ON	OFF	OFF	OFF
3	OFF	OFF	ON	OFF
4	OFF	ON	OFF	OFF
5	OFF	OFF	OFF	ON

† Switching sequence for clockwise shaft rotation as viewed from nameplate end of motor. Steps are performed in reverse order for counterclockwise rotation.

In the Full-Step, One Winding On mode, motor torque is 60% to 70% of that provided by the two windings on mode and step accuracy may be slightly degraded. However, this mode requires only about 50% of the power required for the two windings on mode.

The translator will be in the Full-Step, One Winding On mode when both the HALF-STEP and the 2 WINDINGS ON switches are open.

**HALF-STEP Mode**

The motor step increment in this mode is 0.9°, thereby allowing finer positioning resolution. Each motor winding will be energized for three steps and will be off for the next five steps. The switching sequence is as shown in the following chart for clockwise motor rotation.

HALF-STEP

SWITCHING STEP	MOTOR LEAD OR TERMINAL			
	RED (1)	WHITE/RED (3)	WHITE/GREEN (4)	GREEN (5)
1	OFF	OFF	OFF	ON
2	ON	OFF	OFF	ON
3	ON	OFF	OFF	OFF
4	ON	OFF	ON	OFF
5	OFF	OFF	ON	OFF
6	OFF	ON	ON	OFF
7	OFF	ON	OFF	OFF
8	OFF	ON	OFF	ON
9	OFF	OFF	OFF	ON

† Switching sequence for clockwise shaft rotation as viewed from nameplate end of motor. Steps are performed in reverse order for counterclockwise rotation.

In addition to providing finer positioning resolution, the Half-Step mode also permits starting at higher pulse rates in many cases. Smoother operation at frequencies near the natural resonance points of the motor is another benefit.

To operate in the half-step mode, close the HALF-STEP switch. The oscillator pulse rate is doubled when the half-step mode is selected, resulting in the same motor shaft speed as in the full-step mode.

The switches which select the operating mode must not be changed while the translator is energized. Changing the mode with the power on may cause the motor shaft to change position by 1.8°. Having the HALF-STEP and 2 WINDINGS ON switches closed simultaneously is not allowed.

**Functions of the Operating Controls**

The use of the HALF-STEP and 2 WINDINGS ON switches has been described in the discussion of operating modes. The functions of the other controls are described here.

**BASE LEVEL Control**

This control, located on the back of the unit, controls the base speed of the translator. The base speed is the rate at which a specific motor and load will start and stop without faltering, stalling or missing steps. The base speed range is 0 to 1000 steps per second in the full-step mode and 0 to 2000 steps per second in the half-step mode.

**OPERATION** continued**POWER Switch and Lamp**

This switch controls the a-c power input to the translator. When the translator is energized, the red pilot lamp will light.

**HI/BASE Switch**

This switch controls the speed range at which the translator will drive the motor when operating from the internal oscillator. When the switch is in the BASE position, the motor will be driven at the rate selected on the BASE LEVEL control. If the switch is changed to the HI position, the translator will accelerate the motor to the rate selected on the SPEED control.

**RUN Switch**

This switch will operate the motor from the internal oscillator. Hold the switch in the + position to drive the motor clockwise and in the - position for counterclockwise rotation. The speed at which the motor will be driven depends on the position of the BASE/HI switch and the settings on the BASE LEVEL and speed controls.

**SPEED Control**

This control selects the stepping rate when operating in the high speed range. The range of adjustment is 100 to 3000 steps per second in the full-step mode and 200 to 6000 steps per second in the half-step mode. The stepping rate is doubled when the translator is switched from the full-step to the half-step mode, resulting in the same actual motor shaft speed in both modes.

**External Controls****DIRECTION Switch**

This switch selects the direction in which the motor shaft will rotate when operating from the external RUN switch. The DIRECTION switch must be in the OFF position when operating from an external pulse source.

**RUN Switch**

Closing this switch will cause the translator to begin driving the motor in the direction selected on the DIRECTION switch. The motor would be driven either at the base rate or at the high speed, depending on the position of the HI SPEED switch.

**HI SPEED Switch**

When this switch is closed, the translator will drive the motor at the high speed rate when operating from the internal oscillator. Opening the switch will result in operation at the base speed rate. This switch will not affect operation from the translator panel controls.

**JOG Switch**

Each time this switch is closed and opened, the motor will be driven one step. The direction of rotation is determined by the position of the JOG DIR switch.

**JOG DIR Switch**

This switch selects the direction of motor rotation for operation from the external JOG switch. When the switch is in the CW direction (terminal 8 connected to terminal 5) closing the JOG switch will cause the motor to move one step in the plus (CW) direction. For motion in the minus (CCW) direction, the JOG DIR switch must be in the CCW position (terminal 8 connected to terminal 2). The JOG DIR switch should be in the Off position when the JOG mode is not being used.

**Operating From the Internal Oscillator**

The procedure given below must be followed when operating from the internal oscillator.

1. Select the stepping mode: Full-Step, Two Windings On; Full-Step, One Winding On; or Half-Step
2. Place the POWER switch in the ON position. The red pilot lamp will light.
3. Select the stepping range on the HI/BASE switch.
4. Operate the motor by holding the RUN switch in the + or - position.

When the RUN switch on the front panel is in its center position, the translator can be operated from the external controls as follows:

1. To operate in the run mode, select CW or CCW motion on the Direction switch and select the base or the high speed with the HI SPEED switch. Close the RUN switch to operate the motor.
2. To jog the motor, place the JOG DIR switch at CW or CCW. Then close and open the JOG switch. The motor will move one step in the selected direction each time the JOG switch is closed.

Each time the JOG switch is closed and opened, the translator will drive the motor one step in the direction selected.

**Operating From External Pulses**

Use the following procedure when triggering the translator from an external pulse source.

1. Place the external DIRECTION switch in the OFF position.
2. Select the stepping mode: Full-Step, Two Windings On; Full-Step, One Winding On; or Half-Step.
3. Place the POWER switch in the ON position. The red pilot lamp will light, indicating the translator is energized.
4. Apply pulses from the external source to terminal 5 for CW motion or to terminal 2 for CCW motion. The pulses must meet the specifications given in the section titled "Triggering Requirement."

Ramping of the pulse rate may be necessary in order to start and stop the motor without missing steps.

**Monitoring Pulses**

If it is necessary to monitor pulses from the oscillator in order to keep track of motor position or for any other reason, this can be done as follows:

1. Connect the ground of the pulse monitoring device to terminal 1 (Vo).
2. Connect the probe of the pulse monitoring device (typical high input impedance of 10 megohms) to terminal 2 to monitor CCW pulses or to terminal 5 to monitor CW pulses.

### Base Speed Adjustment

The base speed is the rate at which a specific motor and load will start or stop without faltering, stalling or missing steps. Base speed is easily adjusted to match the motor and load characteristics by means of the Base Speed Control located on the back of the unit. The range is 0 to 1000 steps per second in the full-step mode and 0 to 2000 steps per second in the half-step mode. Base speed must be properly adjusted before setting the ramps (acceleration and deceleration). Set the base speed using the following procedure:

1. Select the desired mode of operation: Full-Step, Two Windings On; Full-Step, One Winding On; or Half-Step.
2. Turn the POWER switch ON.
3. Place the HI/BASE switch in the BASE position.
4. Actuate the RUN switch in either the plus or the minus direction. The translator will begin driving the motor at the base speed.
5. Adjust the Base Speed Control to select the fastest rate at which the translator will reliably start and stop the

motor. Then decrease the base speed by 20 steps per second or 10%, whichever is greater, to provide a safety margin. If necessary, the oscillator pulses can be monitored as previously described while adjusting the base speed.

### Acceleration and Deceleration Adjustments

Acceleration and deceleration times for operation at the high speed are independently adjustable within a 50 millisecond to 1 second range and are adjusted at the factory to 1 second. When the HI/BASE switch is in the HI position and the RUN switch is closed, the oscillator will ramp up to the selected high speed over the selected acceleration time and will ramp down to zero over the selected deceleration time when the RUN switch is opened.

It is often desirable to decrease the acceleration and deceleration times in order to shorten the time required for an operation. However, if the times are too short, the motor may miss steps when starting or overshoot when stopping.

Adjust the ramp times as follows:

**CAUTION:** Voltages are present inside the enclosure of the unit which can cause injury. Therefore, only persons qualified to service electronic equipment should perform adjustments or trouble shooting procedures on this unit with the cover removed.

1. Remove the four screws that hold the cover in place and remove the cover.
2. Place the HI/BASE switch in the HI position.

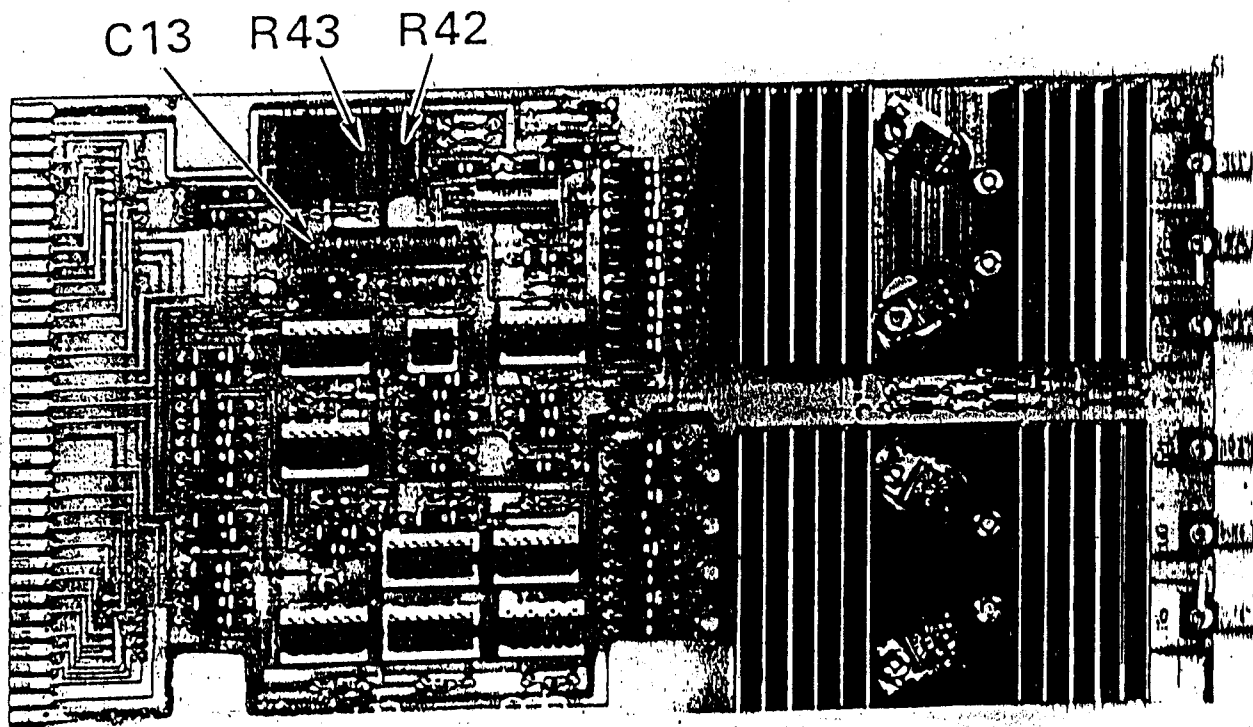

ACCELERATION AND DECELERATION ADJUSTMENTS  
FIGURE 4

**OPERATION** continued

3. Place the POWER switch in the ON position.
4. Refer to Figure 4 and connect the scope probe to capacitor C3 (0.47 microfarad capacitor) on the Translator circuit board and connect the scope probe ground to terminal 1.
5. Select a base speed as described in the Base Speed Adjustment procedure.
6. Hold the RUN switch in the plus or the minus position and adjust the SPEED control to attain the desired high speed rate. Release the RUN switch.
7. Operate the motor by closing the RUN switch and check to see that it does not falter or stall when starting. To select the ideal acceleration time, turn potentiometer R43 on the Translator circuit board ( see Figure 4 ) counterclockwise to shorten the time. Select the minimum time which will allow the motor to start the load reliably. Then increase the acceleration time from this point by 10% to provide an adequate safety margin.
8. Again, start and stop the motor repeatedly, this time observing the time between the opening of the RUN switch and stopping of the motor.

To select the ideal deceleration time, turn potentiometer R42 ( see Figure 4 ) counterclockwise to shorten the deceleration time. Find the shortest time which will allow the motor to stop without gaining or losing steps. To allow an adequate safety margin, increase the deceleration time approximately 10% from this point. The final adjustment will usually result in a deceleration time that is slightly shorter than the acceleration time.

It may be desirable to trigger the scope externally to observe the ramps. To do this, place the scope trigger on External, Trigger — (minus) on the RUN switch to observe the acceleration time and + (plus) on the RUN switch to observe the deceleration time.

**TROUBLE SHOOTING**

**CAUTION:** Voltages are present inside the enclosure of the unit which can cause injury. Therefore, only persons qualified to service electronic equipment should perform adjustments or trouble shooting procedures on this unit with the cover removed.

The SLO-SYN Translator requires no regular maintenance and should provide long service with no attention. Should the unit fail to step the motor properly, perform the following checks:

1. Check all fuses.
2. Check all installation wiring carefully for wiring errors or poor connections.
3. Check to see that the a-c power to the translator meets the stated specifications.
4. Verify that dropping resistors of the correct value have been installed in the motor common leads.
5. Be sure that the proper procedure is being followed in operating the translator.
6. Check to see that triggering pulses are being received at terminal 2 for CCW motion or at terminal 5 for CW motion. Pulses must not be sent to terminals 2 and 5 simultaneously.

7. Check with a d-c voltmeter to verify that voltage to the motor windings is being switched on and off in the proper sequence. Voltage to the motor windings can be checked at terminals M1, M3, M4 and M5. In the Full-Step, Two Windings On mode, each winding should be energized for two steps and de-energized for the next two steps. In the Full-Step, One Winding On mode, each winding should be energized for one step and de-energized for three steps. When operating in the Half-Step mode, each of the four motor windings will be energized for three steps and de-energized for five steps. These tests should be performed at low speeds using the single-step jog circuit.

Proper energizing of the motor windings can also be checked at higher speeds using an oscilloscope to check the collector to emitter waveform (VOE) of the four power transistors. Connect the scope ground to terminal 1. With the scope probe (triggered internally or externally) check at terminals M1, M3, M4 and M5 one at a time. A typical waveform is shown for an M092-FC09 motor operated at 500 full-steps per second (1000 half-steps per second).

8. If the motor will not drive the load at the desired speed and the preceding checks show the translator is operating correctly, the combination of friction load and inertia may be too great for the motor to overcome. This situation can usually be overcome by reducing the operating speed. In severe cases, it may be necessary to use a motor having a higher torque rating or to drive the load through a speed reduction gear train.

If any unusual problems are encountered in the installation or operation of the SLO-SYN Translator, contact the factory or the nearest Superior Electric sales office.



**SPECIFICATIONS**

Dimensions	depth: 16½" (419mm) width: 17½" (445mm) height: 7" (178mm)
Weight (Approximate)	28 pounds (12.7 kg)
Required Power Source	120 volts a-c ± 10%, 60 hertz, 5 ampere max.
Temperature Range	operating: 0°C to +40°C storage: -55°C to +85°C
Oscillator Range	0 to 6000 pulses per second
Oscillator Stability	± 10% or ± 20 steps per second, whichever is greater, over stated temperature and input voltage ranges.
High Speed Range	
Full-Step Mode	100 to 3000 pulses per second
Half-Step Mode	200 to 6000 pulses per second
Base Speed Range	
Full-Step Mode	0 to 1000 pulses per second
Half-Step Mode	0 to 2000 pulses per second

Acceleration and  
Deceleration ..... 50 milliseconds to 1 second  
individually adjustable

External Triggering Pulse  
Requirements

High Level	2.0 VDC to 7.0 VDC
Low Level	0 to 0.4 VDC
Pulse Width	10 microseconds min.
Rise Time	1 microsecond max.
Fall Time	1 microsecond max.
Loading	1.6 mA max.
Trigger Edge	logic 0 to logic 1 transition

**HALF-STEP, 2 WINDINGS ON,  
RUN and HI SPEED Control**

High Level	2.0 VDC to 10 VDC
Low Level	0 to 0.75 VDC
Loading	2 mA max.
Motor Compatibility	drives M061 through M112 motors (using appropriate series resistors)
Stepping Modes	full-step, one or two windings on, 2-phase, bifilar; or half-step, 2-phase, bifilar

**WARRANTY AND LIMITATION OF LIABILITY**

The Superior Electric Company (the "Company"), Bristol, Connecticut, warrants to the buyer of equipment manufactured and sold by the Company that such equipment will be free from defects in material and workmanship under normal use and service for a period of one year from date of shipment from the Company's factory or a warehouse of the Company. THE COMPANY'S OBLIGATION UNDER THIS WARRANTY SHALL BE STRICTLY AND EXCLUSIVELY LIMITED TO REPAIRING OR REPLACING, AT THE FACTORY OR A SERVICE CENTER OF THE COMPANY, ANY SUCH EQUIPMENT OR PARTS THEREOF WHICH AN AUTHORIZED REPRESENTATIVE OF THE COMPANY FINDS TO BE DEFECTIVE IN MATERIAL OR WORKMANSHIP UNDER NORMAL USE AND SERVICE WITHIN SUCH PERIOD OF ONE YEAR. THE COMPANY RESERVES THE RIGHT TO SATISFY SUCH OBLIGATION IN FULL BY REFUNDING THE FULL PURCHASE PRICE FOR ANY SUCH DEFECTIVE EQUIPMENT. This warranty does not apply to any equipment which has been tampered with or altered in any way, which has been improperly installed or which has been subject to misuse, neglect or accident.

THE FOREGOING WARRANTY IS IN LIEU OF ANY OTHER WARRANTIES, EXPRESS OR IMPLIED, INCLUDING, WITHOUT LIMITATION, ANY IMPLIED WARRANTY OF MERCHANTABILITY OR FITNESS FOR A PARTICULAR PURPOSE, and of any other obligations or liabilities on the part of the Company, and no person is authorized to assume for the Company any other liability, with respect to equipment sold by the Company. The Company shall have no liability with respect to equipment not of its manufacture. THE COMPANY SHALL HAVE NO LIABILITY WHATSOEVER IN ANY EVENT FOR PAYMENT OF ANY INCIDENTAL OR CONSEQUENTIAL DAMAGES, INCLUDING, WITHOUT LIMITATION, DAMAGES FOR INJURY TO ANY PERSON OR PROPERTY.

Written authorization to return any equipment or parts thereof must be obtained from the Company. The Company shall not be responsible for any transportation charges.

IF FOR ANY REASON ANY OF THE FOREGOING PROVISIONS SHALL BE INEFFECTIVE, THE COMPANY'S LIABILITY FOR DAMAGES ARISING OUT OF ITS MANUFACTURE OR SALE OF EQUIPMENT, OR USE THEREOF, WHETHER SUCH LIABILITY IS BASED ON WARRANTY, CONTRACT, NEGLIGENCE, STRICT LIABILITY IN TORT OR OTHERWISE, SHALL NOT IN ANY EVENT EXCEED THE FULL PURCHASE PRICE OF SUCH EQUIPMENT.

Any action against the Company based upon any liability or obligation arising hereunder or under any law applicable to the Company's sale of equipment, or the use thereof, must be commenced within one year after the cause of such action arises.

# O/E/N 34 MINIATURE FLAT PACK RELAY

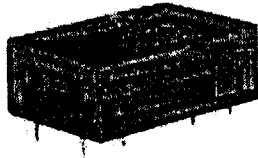

- Low Profile
- High Sensitivity
- Direct PCB type
- Bifurcated Contact
- Sealed

## SPECIFICATIONS

Contact Arrangement	: 2 Form C, 4 Form C
Contact Material	: Silver Gold Flashed
Contact Rating	
Rated Voltage	: 230 VAC/24 VDC
Maximum Voltage	: 230 VAC/220 VDC
Maximum Continuous Current	: 2A @ 30VDC 0.5A @ 125VAC
Maximum Power Rating AC Voltage	: 100VA
Nominal Coil Power	
2 Form C	: 0.3W
4 Form C	: 0.48W
Operating Power	
2 Form C	: 0.18W
4 Form C	: 0.28W
Life Expectancy	
Mechanical	: 10 <sup>7</sup> operations
Electrical	: 2 x 10 <sup>5</sup> operations
Contact Resistance (Initial)	: 50 milli Ohms
Dielectric Strength	
Between Contacts & Coil	: 1000 VRMS
Between Open Contacts	: 500 VRMS
Insulation Resistance	: 1000 Meg. Ohms at 500VDC, 25°C, RH50
Operate time at Nominal Voltage	: 15 milli sec. (Max)
Release time at Nominal Voltage	: 5 milli sec. (Max)
Ambient Temperature	: -40°C to +65°C
Weight	2C : 14 gms (approx) 4C : 16 gms (approx)

### Typical applications

Telecommunication Equipments, Office Automation, Measuring Instruments, etc.

All dimensions are in mm. Specifications subject to change without notice.  
General Tolerance ± 0.5

## COIL DATA

Contact Arrangement	Nominal Voltage VDC	Pick-up Voltage VDC (Max)	Coil Resistance Ohms ± 10%
2C	5	4.0	90
	6	4.8	137
	12	9.6	500
	24	19.2	2000
	48	38.4	7000
	60	48.0	9700
4C	5	4.0	53
	6	4.8	90
	12	9.6	330
	24	19.2	1200
	48	38.4	4200
	60	48.0	7000

## HOW TO ORDER

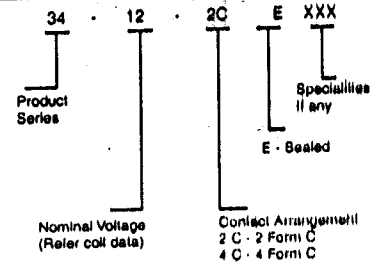

## DIMENSIONS

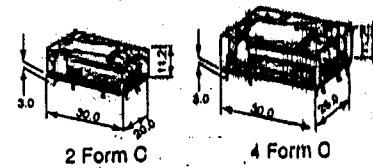

## DRILLING PATTERN

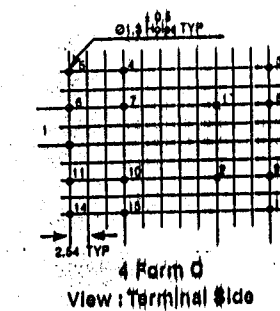
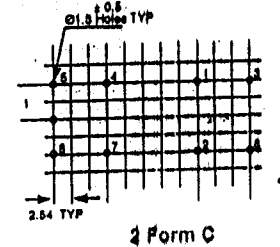

## CIRCUIT DIAGRAMS

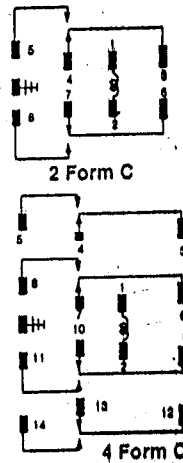

**O/E/N India Limited**

Vyttila, Cochin-682 019, Kerala, India. Ph:0091 (0) 484-301132, 303709  
Fax:0091 (0) 484-302287, 302211. www.oenindia.com. E-mail: sales@oenindia.com

## ***BIBLIOGRAPY***

---

1. Title : **THE HANDBOOK OF ANTENNA DESIGN(Volume I)**  
Authors : A. W. Rudge, K. Milne, A. D. Olver & P. Knight  
Publishers: IEE Publishing
  
2. Title : **ANTENNA THEORY: ANALYSIS AND DESIGN**  
Author : Constantine A. Balanis  
Publishers : Wiley Textbooks
  
3. Title : **MODERN ANTENNA DESIGN**  
Author : Thomas A. Milligan  
Publishers: McGraw- Hill Book Company
  
4. Title : **ANTENNA THEORY AND DESIGN**  
Authors : Warren L. Stutzman & Gary Thiele  
Publishers : Wiley Textbooks
  
5. Title : **ANTENNAS**  
Authors : John D. Kraus & Ronald J. Marhefka  
Publishers : Tata McGraw- Hill
  
6. Title : **IEEE- 488 GENERAL PURPOSE  
INSTRUMENTATION BUS MANUAL**  
Author : Anthony J. Caristi  
Publishers : Academic Press INC.
  
7. Title : **PARALLEL PORT COMPLETE**  
Author : Jan Axelson  
Publishers: Independent Publishers Group