

An Experimental test for the existence of Non-Classical paths in Interference Experiments



A THESIS SUBMITTED TOWARDS THE
PARTIAL FULFILMENT OF THE
5 YEAR INTEGRATED M.Sc. DEGREE PROGRAMME IN PHOTONICS
BY

Animesh Aaryan

UNDER THE GUIDANCE OF

Prof. Urbasi Sinha

ASSOCIATE PROFESSOR, LAMP GROUP, RRI

INTERNATIONAL SCHOOL OF PHOTONICS | CUSAT

Certificate

This is to certify that this thesis entitled “An Experimental test for the existence of Non-Classical paths in Interference experiments” submitted towards the partial fulfillment of the 5 Year Integrated M.Sc. degree programme in Photonics at the International School of Photonics, CUSAT represents original research carried out by “Animesh Aaryan” (Reg. No.96090001) at “Raman Research Institute, Bangalore”, under the supervision of “Prof. Urbasi Sinha” during the academic period 2013-2014.

Student
ANIMESH AARYAN

Supervisor
PROF. URBASI SINHA

Acknowledgements

My journey in the field of Quantum Optics started on December 19, 2013 and it has been an extraordinary time for me since then. Here I would like to take this opportunity to thank the people who have in no small way made the research in this thesis possible.

First and foremost, I would like to thank my advisor, Prof. Urbasi Sinha, for all the moments I shared with her in her group. I have enjoyed a very pleasant working relation with her and benefited enormously from her incredible intuition and enthusiasm for physics. I deeply thank her for the unprecedented freedom she offered to explore my intellectual curiosity in our experiments. I also thank her for her thoughtful advice on other matters.

I had the pleasure of working with several extremely talented and and enthusiastic colleagues during the past months - they really deserve most thanks: Pradeep, Debadrita, Karthik, Aravind and Ashutosh. I and Pradeep joined the group almost at the same time and we spent most of our time together discussing our doubts. This work could not have been possible without the hard work of Pradeep who did a terrific job in simulating the triple slit experiment. The weekly group meetings played a key role in knowing each other's work. I had a very good time discussing papers with Ashutosh and Debadrita. Just as important were the contributions from the excellent staff of the RRI mechanical workshop, and all other people who make RRI work. I cannot forget to thank Dr. Pramod A Pullarkat and his students for letting us to image the masks in their lab. Special thanks to Karthik and Aravind for helping me with latex .

Lastly but not the least, I would thanks my parents for their unconditional love and support. This thesis has been possible because of their faith and sacrifice in my education and research. Its them to whom I dedicate this thesis.

Dedicated to my family for lending me your happiness, love and care.

Abstract

Quantum mechanical explanation of a double slit interference experiment takes the assumption that the wave function at the screen with both slits open is exactly the sum of the wave function with the slits individually open one at a time. This is done by applying the superposition principle which is commonly used in many popular textbooks and literature. Application of super-position principle is approximately true in this case as the three scenarios mentioned above represent three different boundary conditions. Addition of solutions to the wave-function with two different boundary conditions can't give a solution of the wave function with a third boundary condition and therefore there has to be a correction term. In order to quantify this correction term one can appeal to Feynman path integral formalism. This quantification in terms of non-classical path has recently been demonstrated theoretically in our group. In this thesis, the experimental test for the existence of such non-classical paths is attempted.

Contents

1	Introduction and Statement of the problem	9
2	Quantification of κ	12
3	Feynman's Path Integral Formalism	14
3.1	Physical Intuition	15
3.2	The Propagator	16
3.3	Derivation of the Path Integral	17
3.4	Schrodinger Equation from Path Integral	20
4	Experimental Procedure	22
4.1	Design Consideration	22
4.1.1	Setting up the slits	22
4.1.2	Imaging the slits and the masks	22
4.1.3	Processing the images	24
4.1.4	Assembling the microscope	24
4.2	Simulating the experiment	27
5	Future work	32

List of Figures

1	Incorrect Wavefunction hypothesis	9
2	Illustration of different cases	10
3	Paths excluded from $\psi_A + \psi_B$	11
4	A triple slit system	13
5	Feynman paths between A and B	16
6	Image of the triple slit	22
7	Slit and Mask used for different combinations	23
8	Different combinations in the opening masks	24
9	Profile of intensity vs distance	24
10	Schematic of the microscope	25
11	Assembled microscope	26
12	Intensity distribution, slit A open	28
13	Intensity distribution, slit B and C open	29
14	Intensity distribution, all slits open	30
15	Comparison of the Intensities	31
16	Experimental Setup using an attenuated laser source	33

”I think I can safely say that nobody understands quantum mechanics.”

- Richard Feynman

1 Introduction and Statement of the problem

The wave function is the most fundamental concept of quantum mechanics. It was first introduced into the theory by analogy (*Schrodinger 1926*); the behaviour of microscopic particles like waves, and thus a wave function is used to describe them. Schrodinger originally regarded the wave function as a description of real physical wave. But this view met serious objections and was soon replaced by Born's probability interpretation[9] (*Born 1926*), which becomes the standard interpretation of the wave function today. According to this interpretation, the wave function is a probability amplitude, and the square of its absolute value represents the probability density for a particle to be measured in certain locations.

The most common approach to compute the behaviour of a wave function is to write that wave function as a superposition of many other wave functions of a certain type-stationary states whose behaviour is particularly simple. This superposition principle is used to obtain the approximate solutions of the wave equation.

Now, let us consider the Young's well known double slit experiment[8] with incident photons. The wave function at the detector with slit A open is ψ_A . The wave function at the detector with slit B open is ψ_B . And thus the wave function with both slits open is assumed to be $\psi_A + \psi_B$ using the superposition principle. This naive assumption (*referred as Wave function hypothesis*) is approximately true as the three scenarios represent three different boundary boundary conditions [1],[7], and superposition should not be valid in such case.

$$\psi_A + \psi_B \neq \psi_{AB} \tag{1}$$

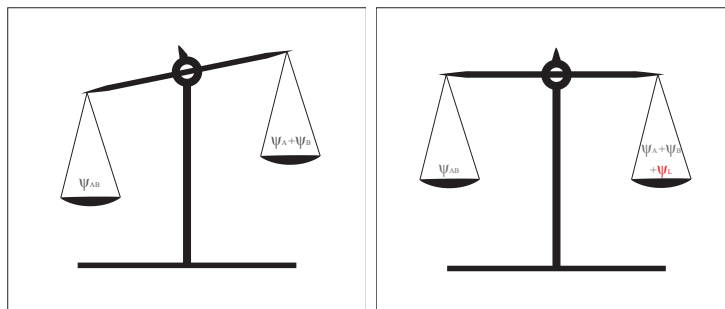

(a) Wave function hypothesis (b) Wave function correction

Figure 1: Incorrect Wavefunction hypothesis

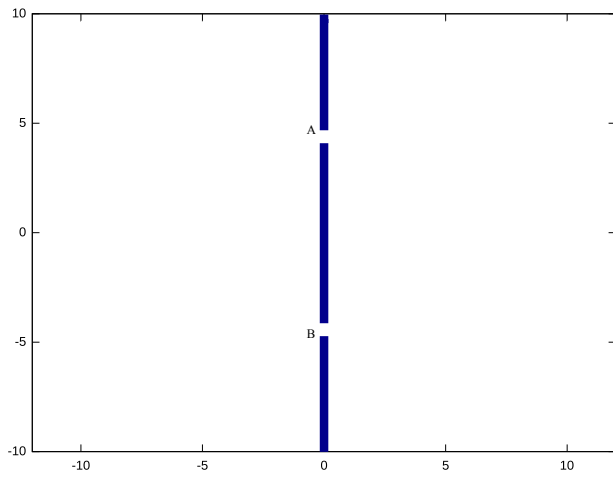

(a) the double slit system

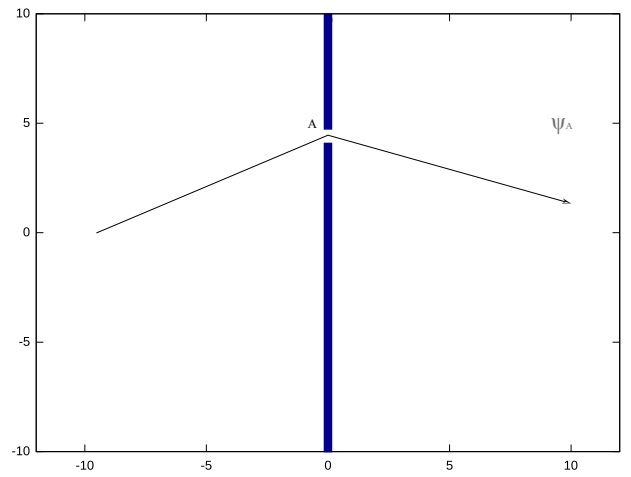

(b) top slit(A) open

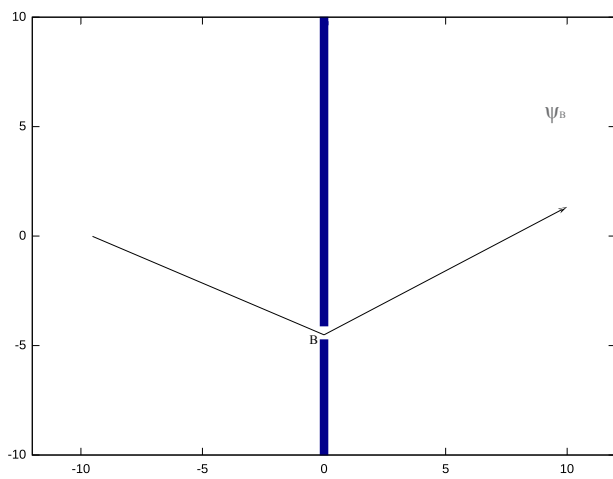

(c) bottom slit(B) open

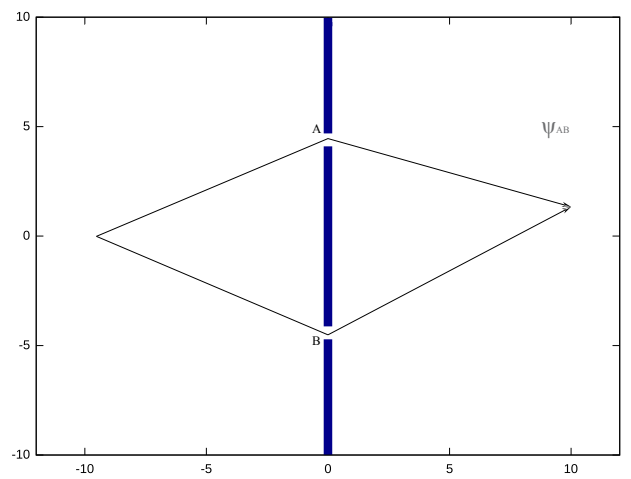

(d) both slits(A and B) open

Figure 2: Illustration of different cases

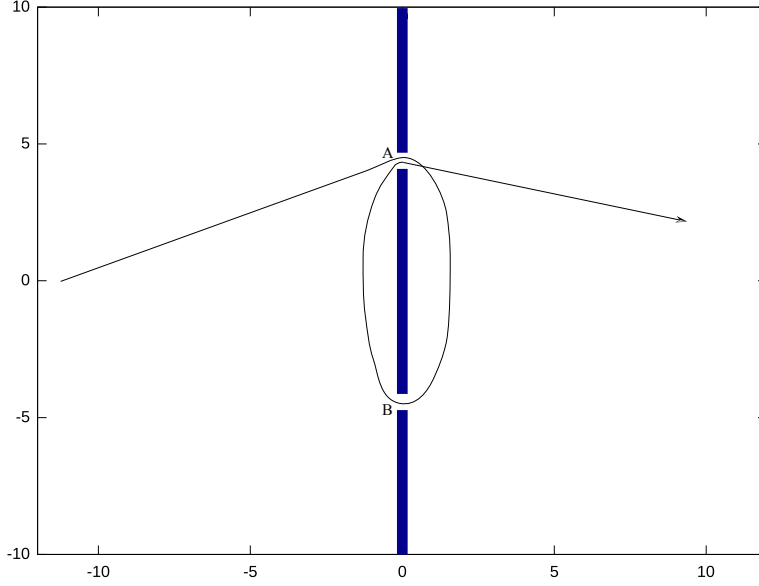

Figure 3: Paths excluded from $\psi_A + \psi_B$

In order to quantify the wave function hypothesis we need to approach it using the Feynman path integral formalism of quantum mechanics. The path integral formalism an integration over all possible paths that can be taken by the photon through the two slits. This not only includes the nearly straight paths from the source to the detector through either slits (the classical paths) but also includes the non-straight paths(non-classical paths). These non classical paths make a much smaller still finite contribution to the total intensity at the detector screen compared to the contribution from the classical paths. Thus, the rectification of the wave function becomes inevitable and is given by:

$$\psi_{AB} = \psi_A + \psi_B + \psi_L \quad (2)$$

2 Quantification of κ

As we saw in the previous section, there are contributions from the non classical paths. In order to experimentally measure this contribution, we define a quantity known as κ .

Let us define some of the following parameters in order to quantify κ (Kappa) in the case of triple slit experiment(Fig.4).

ψ_A := Wavefunction when the top slit A is open .

ψ_B := Wavefunction when the middle slit B is open .

ψ_C := Wavefunction when the bottom slit C is open .

ψ_{AB} := Wavefunction when the slits A and B are open .

ψ_{BC} := Wavefunction when the slits B and C are open .

ψ_{AC} := Wavefunction when the slits A and C are open .

ψ_{ABC} := Wavefunction when all slits are open .

$$P_A := |\psi_A|^2$$

$$P_B := |\psi_B|^2$$

$$P_C := |\psi_C|^2$$

$$\text{Def. } P_{AB} = |\psi_A + \psi_B|^2 = |\psi_A|^2 + |\psi_B|^2 + 2 \text{Re}(\psi_A \overline{\psi_B}) = |\psi_A|^2 + |\psi_B|^2 + 2\phi_{AB}$$

$$\text{Def. } \phi_{AB} = \frac{P_{AB} - P_A - P_B}{2}$$

$$\text{Def. } P_{AC} = |\psi_A + \psi_C|^2 = |\psi_A|^2 + |\psi_C|^2 + 2 \text{Re}(\psi_A \overline{\psi_C}) = |\psi_A|^2 + |\psi_C|^2 + 2\phi_{AC}$$

$$\text{Def. } \phi_{AC} = \frac{P_{AC} - P_A - P_C}{2}$$

$$\text{Def. } P_{BC} = |\psi_B + \psi_C|^2 = |\psi_B|^2 + |\psi_C|^2 + 2 \text{Re}(\psi_B \overline{\psi_C}) = |\psi_B|^2 + |\psi_C|^2 + 2\phi_{BC}$$

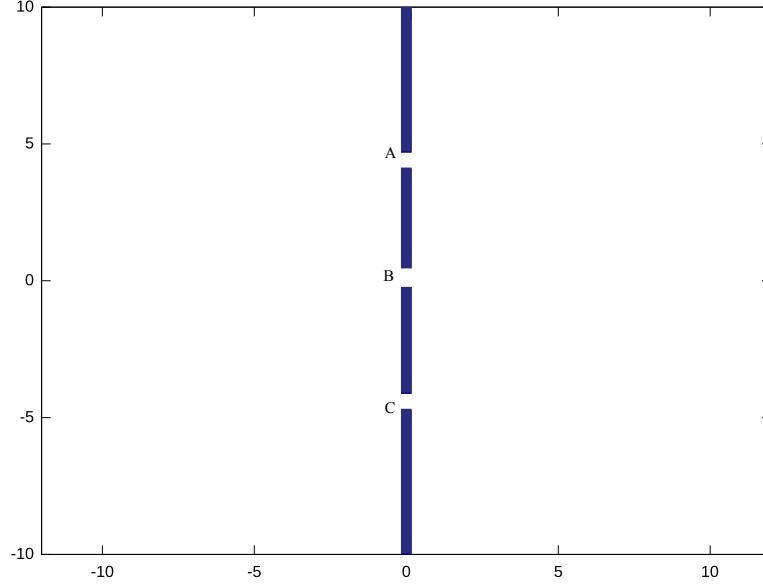

Figure 4: A triple slit system

$$\text{Def. } \phi_{BC} = \frac{P_{BC} - P_C - P_B}{2}$$

$$P_{ABC} = |\psi_A + \psi_B + \psi_C|^2 = \psi_A^2 + \psi_B^2 + \psi_C^2 + 2\phi_{AB} + 2\phi_{AC} + 2\phi_{BC}$$

$$P_{ABC} = P_{AB} + P_{BC} + P_{AC} - P_A - P_B - P_C$$

$$\text{Def. } \kappa = \frac{P_{ABC} - P_{AB} - P_{BC} - P_{AC} + P_A + P_B + P_C}{P_{ABC}(\text{at central maxima})}$$

κ being zero implies that the superposition principle has been used incorrectly. Non-zereness of Kappa will quantify the non-classical contributions.

3 Feynman's Path Integral Formalism

Feynman's formulation of quantum mechanics using the so called path integral is arguably the most elegant. It can be stated in a single line:

$$\langle x_f, t_f | x_i, t_i \rangle = \int \mathcal{D}x(t) e^{iS[x(t)]/\hbar} \quad (3)$$

The equation states that in order to know the quantum mechanical amplitude for a point particle at a position x_i at a time t_i to reach a position x_t at time t_t , we integrate over all possible paths connecting the points with a weight factor given by the classical action for each path. Hence the name "*Path integral*" [5]. The position kets form a complete set of basis, and knowing this amplitude for all x is enough information know everything about the system. The expression is generalized for more dimensions and more particles in a straightforward manner.

This formulation is completely equivalent to the usual formulation of quantum mechanics. On the other hand, there are many reasons why this expression is just beautiful.

First, the classical equation of motion comes out in a very simple way. If we take the limit $\hbar \rightarrow 0$, the weight factor $e^{iS[x(t)]/\hbar}$ oscillates very rapidly. Therefore, we expect that the main contribution to the path integral comes from paths that make the action stationary. This is nothing but the derivation of Euler - Lagrange equation from the classical action. Therefore, the classical trajectory dominates the path integral in the small \hbar limit.

Second, we don't know what path the particle has chosen, even when we know what the initial and final positions are. This is a natural generalization of the two-slit experiment. Even if we know where the particle originates from and where it hit on the screen, we don't know which slit the particle came through. The path integral is an infinite-slit experiment. Because we can't

Third, we gain intuition on what quantum fluctuation does. Around the classical trajectory, a quantum particle "explores" the vicinity. The trajectory can deviate from the classical trajectory if the difference in the action is roughly within \hbar . When a classical particle is confined in a potential well, a quantum particle can go on an excursion and see that there is a world outside the potential barrier. Then it can decide to tunnel through. If a classical particle is sitting at the top of a hill, it doesn't fall; but a quantum particle realizes that the potential energy can go down with a little excursion, and decides to fall.

Fourth, whenever we have an integral expression for a quantity, it is often easier to come up with an approximation method to work it out, compared to staring at

a differential equation. In fact, some techniques in quantum physics couldn't be thought of without the intuition from the path integral.

3.1 Physical Intuition

Let's take the two-slit experiment. Each time a photon hits the screen, there is no way to tell which slit the photon has gone through. After repeating the same experiment many many times, a fringe pattern gradually appears on the screen, proving that there is an interference between two waves, one from one slit, the other from the other. We conclude that we need to *sum* amplitudes of these two waves that correspond to different *paths* of the photon. Now take case when we have more(3 in our case) slits. There are now more paths, each of which contributing an amplitude. As we increase the number of slits, eventually the entire obstruction disappears. Yet it is clear that there are many paths that contribute to the final amplitude of the photon propagating to the screen.

As we generalize this thought experiment further, we are led to conclude that the amplitude of a particle moving from a point x_i to another point x_f consists of many components each of which corresponds to a particular path that connects these two points. One such path is a classical trajectory(Fig. 5). However, there are infinitely many other paths that are not possible classically, yet contribute to the quantum mechanical amplitude. This argument leads to the notion of a *path integral*[7], where we sum over all possible paths connecting the initial and final points to obtain the amplitude.

In order to weight individual paths, one thing is very clear that the weight factor must be chosen such that the classical path is singled out in the limit $\hbar \rightarrow 0$. The correct choice turns out to be $e^{iS[x(t)]/\hbar}$, where

$$S[x(t)] = \int_{t_i}^{t_f} dt L(x(t), \dot{x}(t))$$

is the classical action for the path $x(t)$ that satisfies the boundary condition $x(t_i) = x_i, x(t_f) = x_f$. In the limit $\hbar \rightarrow 0$, the phase factor oscillates so rapidly that nearly all the paths would cancel each other out in the final amplitude. However, there is a path that makes the action stationary, whose contribution is not cancelled. This particular path is nothing but the classical trajectory. This way, we see that the classical trajectory dominates the path integral in the $\hbar \rightarrow 0$ limit. As we increase \hbar , the path becomes "fuzzy". The classical trajectory still dominates, but there are other paths close to it whose action is within $\Delta S \simeq \hbar$ and contribute significantly to the amplitude. The particle does an excursion around the classical trajectory.

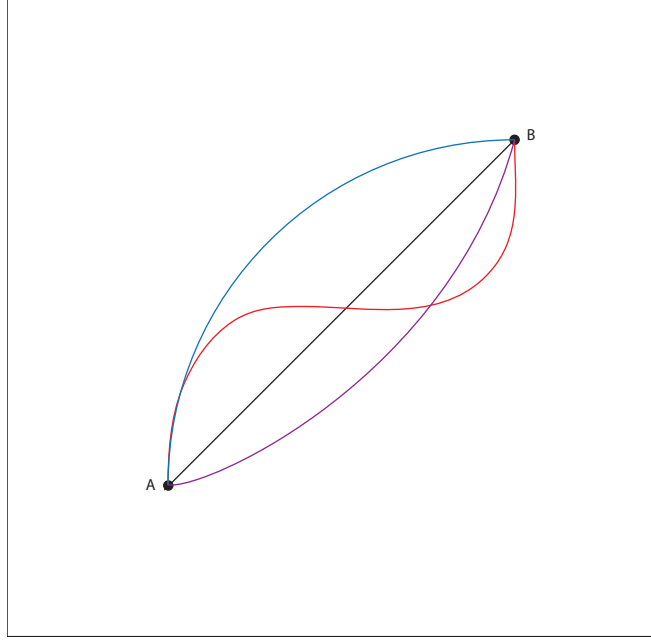

Figure 5: Feynman paths between A and B

3.2 The Propagator

The quantity

$$K(x_f, t_f; x_i, t_i) = \langle x_f, t_f | x_i, t_i \rangle \quad (4)$$

is called propagator. It knows everything about how a wavefunction propagates in time, because

$$\psi(x_f, t_f) = \langle x_f, t_f | \psi \rangle = \int \langle x_f, t_f | x_i, t_i \rangle dx_i \langle x_i, t_i | \psi \rangle \quad (5)$$

$$= \int K(x_f, t_f; x_i, t_i) \psi(x_i, t_i) dx_i \quad (6)$$

This is the *Green's function for the Schrodinger equation*.

The propagator is also written using energy eigen values and eigen states (if the Hamiltonian doesn't depend upon time),

$$\begin{aligned} K(x_f, t_f; x_i, t_i) &= \langle x_f | e^{-iH(t_f-t_i)/\hbar} | x_i \rangle = \sum \langle x_f | n \rangle e^{-iE_n(t_f-t_i)/\hbar} \langle n | x_i \rangle \\ &= \sum e^{-iE_n(t_f-t_i)/\hbar} \psi_n^*(x_f) \psi_n(x_i) \end{aligned} \quad (7)$$

In particular, Fourier analyzing the propagator gives all energy eigenvalues, and each Fourier coefficient the wave functions of each energy eigenstates.

The propagator is a nice package that contains all dynamical information about a quantum system.

3.3 Derivation of the Path Integral

The basic point is that the propagator for a short interval is given by the classical Lagrangian

$$\langle x_1, t + \Delta t | x_0, t \rangle = c e^{i(L(t)\Delta t + O(\Delta t)^2)/\hbar} \quad (8)$$

where c is a normalization constant. This can be easily shown for a simple Hamiltonian

$$H = \frac{p^2}{2m} + V(x) \quad (9)$$

The quantity we want is

$$\langle x_1, t + \Delta t | x_0, t \rangle = \langle x_1 | e^{-iH\Delta t/\hbar} | x_0 \rangle \quad (10)$$

$$= \int dp \langle x_1 | p \rangle \langle p | e^{-iH\Delta t/\hbar} | x_0 \rangle \quad (11)$$

Our interest is in the phase only at $O(\Delta t)$, the last factor can be estimated as $\langle p | e^{-iH\Delta t/\hbar} | x_0 \rangle$

$$\begin{aligned} &= \langle p | 1 - iH\Delta t/\hbar + (\Delta t)^2 | x_0 \rangle \\ &= 1 - \frac{ip^2}{2m}\Delta t - \frac{i}{\hbar}V(x_0)\Delta t + O(\Delta t)^2 \frac{e^{-ipx_0/\hbar}}{\sqrt{2\pi\hbar}} \\ &= \frac{1}{\sqrt{2\pi\hbar}} \exp \frac{-i}{\hbar} \left(px_0 + \frac{p^2}{2m}\Delta t + V(x_0)\Delta t + O(\Delta t)^2 \right) \end{aligned} \quad (12)$$

Then the p – integral is a Fresnel Integral

$$\begin{aligned} \langle x_1, t + \Delta t | x_0, t \rangle &= \int \frac{dp}{2\pi\hbar} e^{ipx_1/\hbar} e^{-i \left(px_0 + \frac{p^2}{2m}\Delta t + V(x_0)\Delta t + O(\Delta t)^2 \right) / \hbar} \end{aligned} \quad (13)$$

$$= \sqrt{\frac{m}{2\pi i \hbar \Delta t}} \exp \frac{i m (x_1 - x_0)^2}{\hbar 2 \Delta t} - V(x_0)\Delta t + O(\Delta t^2) \quad (14)$$

The quantity in the parentheses is nothing but the classical Lagrangian times Δt by identifying $\dot{x}^2 = (x_1 - x_0)^2/(\Delta t)^2$

Once Eq.8 is shown, we use many time slices to obtain the propagator for a finite time interval. Using the completeness relation many many times,

$$\begin{aligned} \langle x_f, t_f | x_i, t_i \rangle &= \int \langle x_f, t_f | x_{N-1}, t_{N-1} \rangle dx_{N-1} \langle x_{N-1}, t_{N-1} | x_{N-2}, t_{N-2} \rangle dx_{N-2} \\ &\dots \dots \dots \langle x_2, t_2 | x_1, t_1 \rangle dx_2 \qquad \qquad \qquad \langle x_1, t_1 | x_i, t_i \rangle dx_1 \end{aligned} \quad (15)$$

The time interval for each factor is $\Delta t = (t_f - t_i)/N$. By taking the limit $N \rightarrow \infty$, Δt is small enough that we can use the formula, and we can find

$$\langle x_f, t_f | x_i, t_i \rangle = \int \prod_{i=1}^{N-1} dx_i e^{i \sum_{i=0}^{N-1} L(t_i) \Delta t / \hbar} \quad (16)$$

upto normalization (here, $t_0 = t_i$.)

In the limit $N \rightarrow \infty$, the integral over all positions at each time can be taken an integral over all possible paths. The exponent becomes a time integral of the Lagrangian, namely the action for each path. This completes the derivation of the path integral in quantum mechanics.

A very crucial point to be noticed is that even matrix elements of operators can be written in terms of path integrals. For example,

$$\begin{aligned} \langle x_f, t_f | x(t_0) | x_i, t_i \rangle &= \int dx(t_0) \langle x_f, t_f | x(t_0), t_0 \rangle x(t_0) \langle x(t_0), t_0 | x_i, t_i \rangle \\ &= \int dx(t_0) \int_{t_f > t > t_0} \mathcal{D}x(t) e^{iS[x(t)]/\hbar} x(t_0) \int_{t_0 > t > t_i} \mathcal{D}x(t) e^{iS[x(t)]/\hbar} \\ &= \int_{t_f > t > t_i} \mathcal{D}x(t) e^{iS[x(t)]/\hbar} x(t_0), \end{aligned}$$

At the last step, we used the fact that an integral over all paths from x_i to $x(t_0)$, all paths from $x(t_0)$ to x_f , further integrated over the intermediate position $x(t_0)$ is the same as the integral over all paths from x_i to x_f . The last expression is literally

an expectation value of the position in the form of an integral. If we have multiple insertions, by following the same steps,

$$\langle x_f, t_f | x(t_2)x(t_1) | x_i, t_i \rangle = \int_{t_f > t > t_i} \mathcal{D}x(t) e^{iS[x(t)]/\hbar} x(t_2)x(t_1) \quad (17)$$

Here we assumed that $t_2 > t_1$ to be consistent with successive insertion of positions in the correct order. Therefore, expectation values in the path integral corresponds to matrix elements of operators with correct ordering in time. Such a product of operators is called “timed-ordered” $Tx(t_2)x(t_1)$ defined by $x(t_2)x(t_1)$ as long as $t_2 > t_1$, while by $x(t_1)x(t_2)$ if $t_1 > t_2$.

Another useful point is that Euler–Lagrange equation is obtained by the change of variable $x(t) \rightarrow x(t) + \delta x(t)$ with $x_i = x(t_i)$ and $x_f = x(t_f)$ held fixed. A change of variable of course does not change the result of the integral, and we find

$$\int \mathcal{D}x(t) e^{iS[x(t)+\delta x(t)]/\hbar} = \int \mathcal{D}x(t) e^{iS[x(t)]/\hbar} \quad (18)$$

and hence

$$\int \mathcal{D}x(t) e^{iS[x(t)+\delta x(t)]/\hbar} - \int \mathcal{D}x(t) e^{iS[x(t)]/\hbar} = \int \mathcal{D}x(t) e^{iS[x(t)]/\hbar} \frac{i}{\hbar} \delta S = 0 \quad (19)$$

From Classical Mechanics we know,

$$\delta S = S[x(t) + \delta(t)] - S[x(t)] = \int \left(\frac{\partial L}{\partial x} - \frac{d}{dt} \frac{\partial L}{\partial \dot{x}} \right) \delta x(t) dt \quad (20)$$

Therefore,

$$\int \mathcal{D}x(t) e^{iS[x(t)]/\hbar} \frac{i}{\hbar} \int \left(\frac{\partial L}{\partial x} - \frac{d}{dt} \frac{\partial L}{\partial \dot{x}} \right) \delta x(t) dt = 0 \quad (21)$$

Since $\delta x(t)$ is an arbitrary change of variable, the expression must be zero at all t independently,

$$\int \mathcal{D}x(t) e^{iS[x(t)]/\hbar} \frac{i}{\hbar} \left(\frac{\partial L}{\partial x} - \frac{d}{dt} \frac{\partial L}{\partial \dot{x}} \right) = 0 \quad (22)$$

Therefore, the Euler–Lagrange equation must hold as an expectation value, nothing but the Ehrenfest’s theorem.

3.4 Schrodinger Equation from Path Integral

Its very important to see if the path integral contains all information we need. In this section we will retrieve Schrodinger equation from the path integral.

Let us first see that the momentum is given by a derivative. Starting from the path integral

$$\langle x_f, t_f | x_i, t_i \rangle = \int \mathcal{D}x(t) e^{iS[x(t)]/\hbar}, \quad (23)$$

we shift the trajectory $x(t)$ by a small amount $x(t) + \delta x(t)$ with the boundary condition that x_i is held fixed ($\delta x(t_i) = 0$) while x_f is varied ($\delta x(t_f) \neq 0$). Under this variation, the propagator changes by

$$\langle x_f + \delta x(t_f), t_f | x_i, t_i \rangle - \langle x_f, t_f | x_i, t_i \rangle = \frac{\partial}{\partial x_f} \langle x_f, t_f | x_i, t_i \rangle \delta x(t_f) \quad (24)$$

On the other hand, the path integral changes by

$$\int \mathcal{D}x(t) e^{iS[x(t)+\delta x(t)]/\hbar} - \int \mathcal{D}x(t) e^{iS[x(t)]/\hbar} = \int \mathcal{D}x(t) e^{iS[x(t)]/\hbar} \frac{i}{\hbar} \delta S \quad (25)$$

From Classical mechanics we know that the action changes by

$$\begin{aligned} \delta S &= S[x(t) + \delta(t)] - S[x(t)] \\ &= \int_{t_i}^{t_f} \left(\frac{\partial L}{\partial x} \delta x + \frac{\partial L}{\partial \dot{x}} \delta \dot{x} \right) dt \\ &= \frac{\partial L}{\partial \dot{x}} \delta x \Big|_{x_i}^{x_f} + \int_{t_i}^{t_f} dt \left(\frac{\partial L}{\partial x} - \frac{d}{dt} \frac{\partial L}{\partial \dot{x}} \right) \delta x. \end{aligned} \quad (26)$$

The last term vanishes because of the equation of motion (which holds as an expectation value, as we saw in the previous section), and we are left with

$$\delta S = \frac{\partial L}{\partial \dot{x}} \delta x(t_f) = p(t_f) \delta x(t_f). \quad (27)$$

By putting them together, and dropping $\delta x(t_f)$, we find

$$\frac{\partial}{\partial x_f} \langle x_f, t_f | x_i, t_i \rangle = \int \mathcal{D}x(t) e^{iS[x(t)]/\hbar} \frac{i}{\hbar} p(t_f). \quad (28)$$

This is precisely how the momentum operator is represented in the position space.

Now the Schrodinger equation can be derived by taking the a variation with respect to t_f . Recalling again from Classical Mechanics:

$$\frac{\partial S}{\partial t_f} = -H(t_f) \quad (29)$$

after using the equation of motion. Therefore,

$$\frac{\partial}{\partial t_f} \langle x_f, t_f | x_i, t_i \rangle = \int \mathcal{D}x(t) e^{iS[x(t)]/\hbar} \frac{-i}{\hbar} H(t_f) \quad (30)$$

If

$$H = \frac{p^2}{2m} + V(x)$$

the momentum can be written using Eq.28, and we recover the Schrodinger equation,

$$i\hbar \frac{\partial}{\partial t_f} \langle x_f, t_f | x_i, t_i \rangle = \frac{-\hbar^2}{2m} \frac{\partial^2}{\partial x_{2f}^2} + V(x_f) \langle x_f, t_f | x_i, t_i \rangle \quad (31)$$

In other words, the path integral contains the same information as the conventional formalism of the quantum mechanics.

4 Experimental Procedure

4.1 Design Consideration

4.1.1 Setting up the slits

In order to measure the eight intensities, a set of two plates is taken[3]. These plates are commercially available and are made of stainless steel and the slits are designed by laser cutting technique. One plate contains the slit pattern while the other contains patterns to block or unblock the slits. This is depicted in the figure below. The different combination are also shown in the picture. The slits are 300 microns in length and 30 microns in width (Fig. 6), where as the opening mask is 600 microns in length and 60 microns in width. The mask is chosen to be of larger dimension that the slit so that complete transmission is achieved. We switch between the different combination(Fig. 7 and Fig. 8) by moving the mask with a linear actuator.

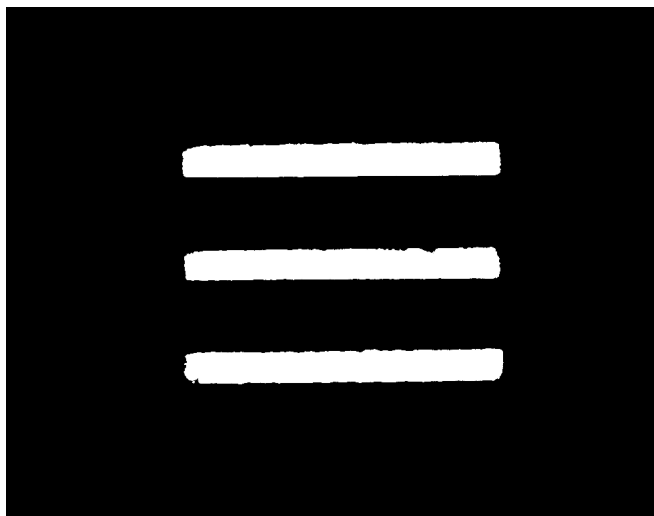

Figure 6: Image of the triple slit

4.1.2 Imaging the slits and the masks

The slit and the masks were imaged using a powerful microscope using 10x magnification. The images of the slit and the opening masks is in Fig. 6 and Fig.8.

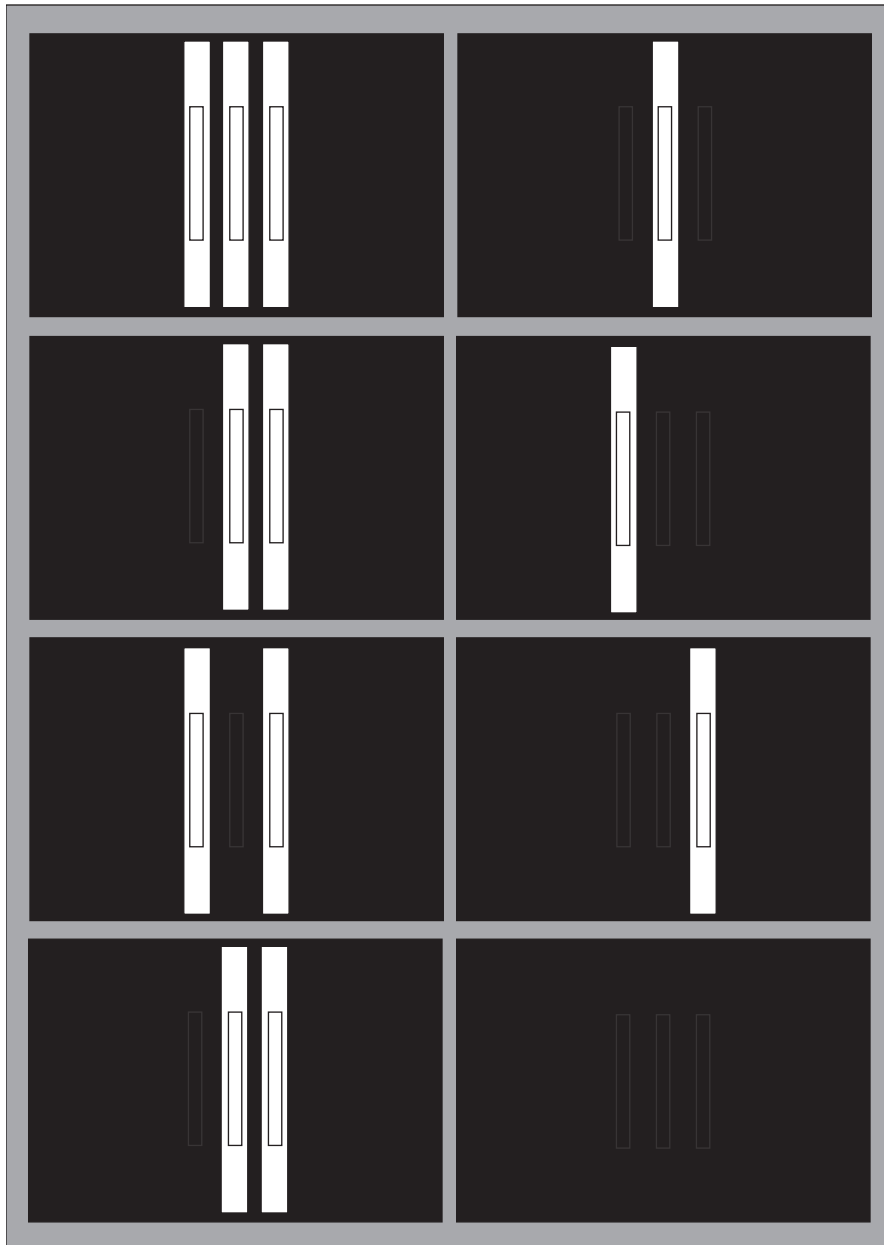

Figure 7: Slit and Mask used for different combinations



Figure 8: Different combinations in the opening masks

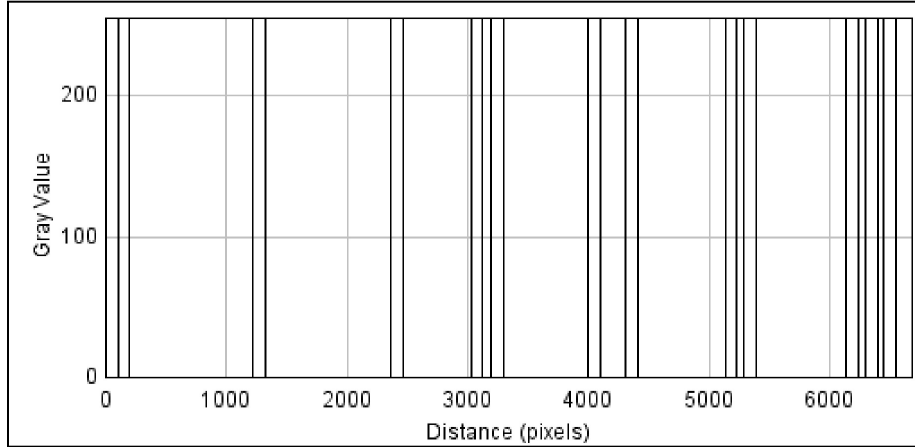

Figure 9: Profile of intensity vs distance

4.1.3 Processing the images

The images were processed using Matlab and ImageJ software. In order to find the width and length of the images, the image profile function is used. The grayscale images are converted to binary and using the image profile technique the edges of the slits and masks are known. The profile image is shown in Fig. 9.

As we see, the slits are 30 microns width, any misalignment in the opening masks can lead to a variation in Kappa. The profiling technique helps us to find the offset if any. In order to know the precision of this profiling technique, the process was repeated for a mask slit with a known offset of 8 microns in one of the combination. Using the above mentioned techniques, an offset of 11 microns was found in the given combinations.

4.1.4 Assembling the microscope

As mentioned in the previous section, we want to switch between the different combination. Therefore, a microscope becomes one of the most important tool for our experiment.

The microscope was assembled (Fig.11) using a 10x objective lens from Newport

and Co. The schematic diagram for the microscope is drawn below (Fig. 10):

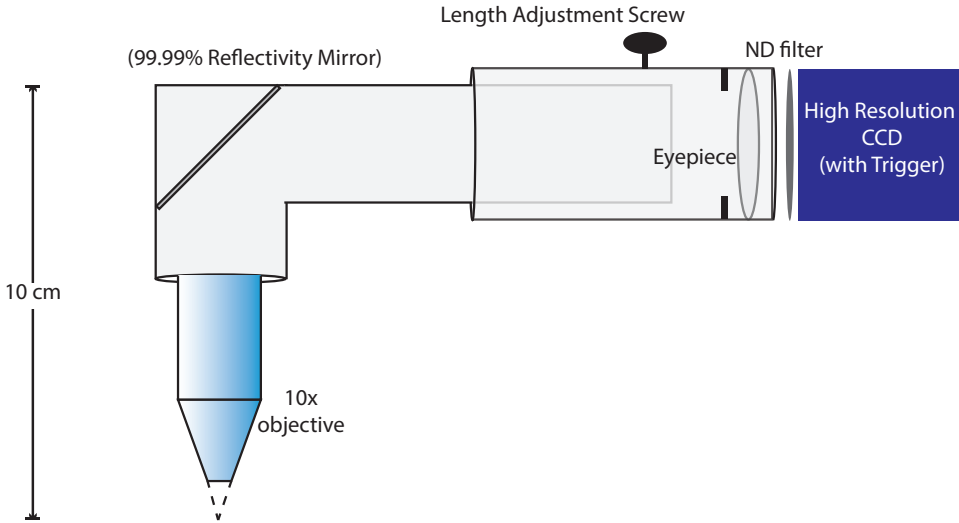

Figure 10: Schematic of the microscope

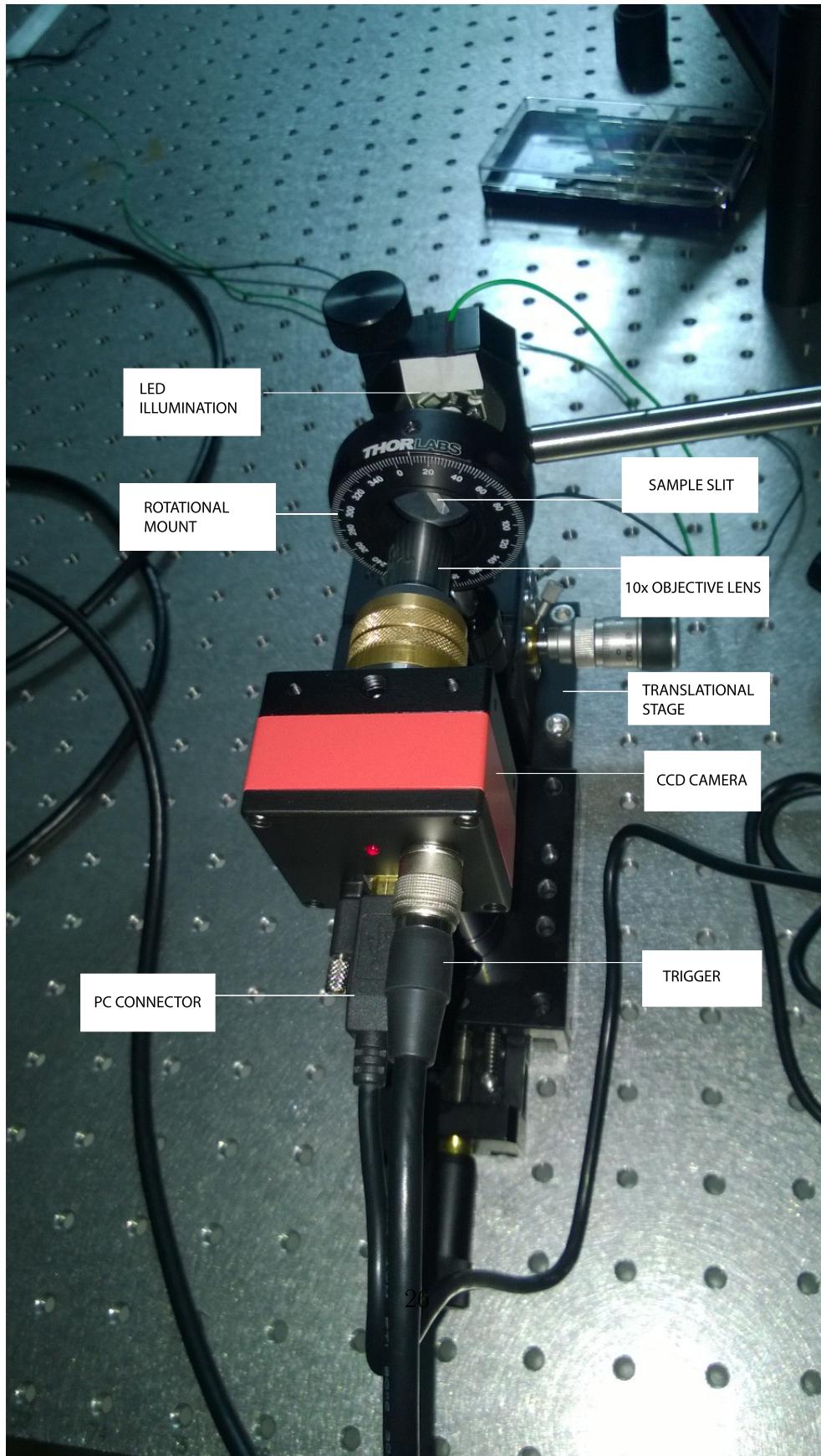
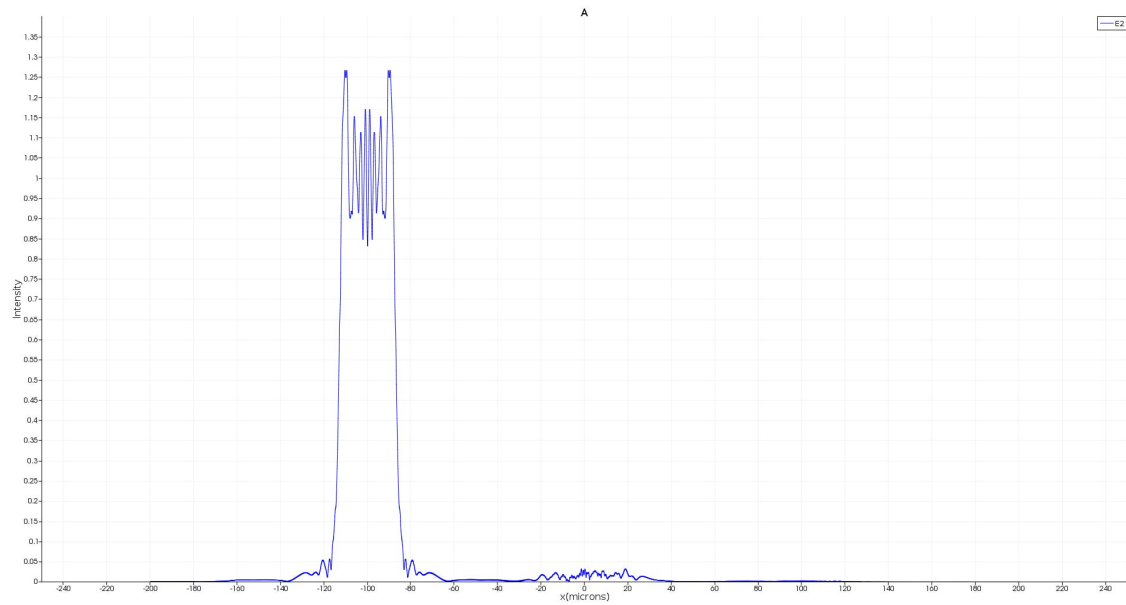

Figure 11: Assembled microscope

4.2 Simulating the experiment

The experiment was first simulated using Finite Difference Time Domain technique. This simulation was performed by one of the members in our group. This simulation provided an insight to what may happen to kappa, if there are any offsets in any of the combinations. This technique is extremely powerful. Few results using this technique is shown below:



(a) Intensity at near field

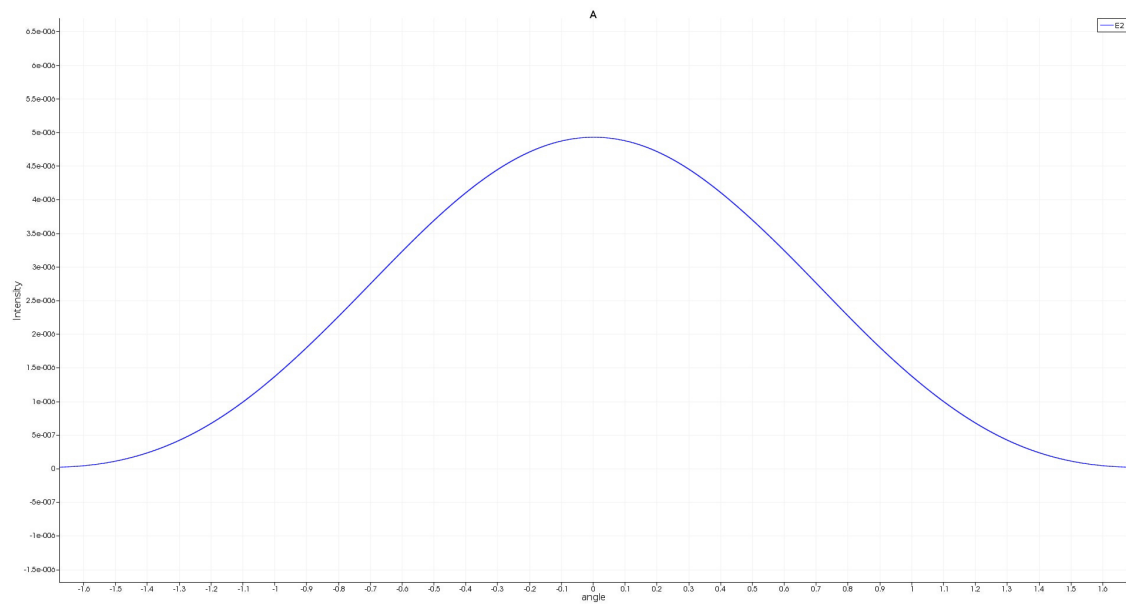

(b) Intensity at far field

Figure 12: Intensity distribution, slit A open

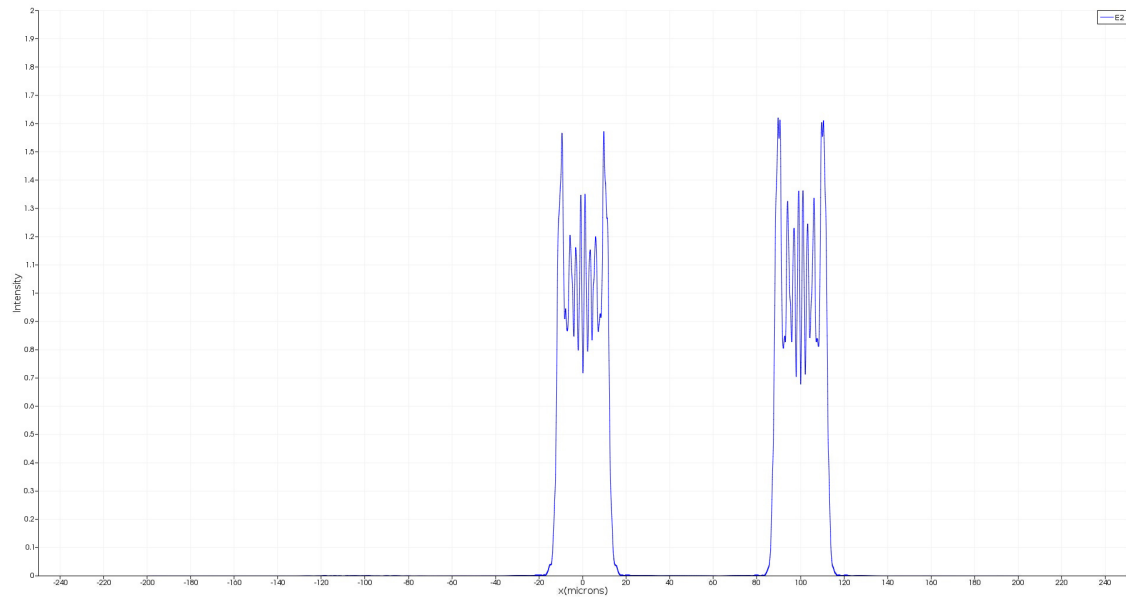

(a) Intensity at near field

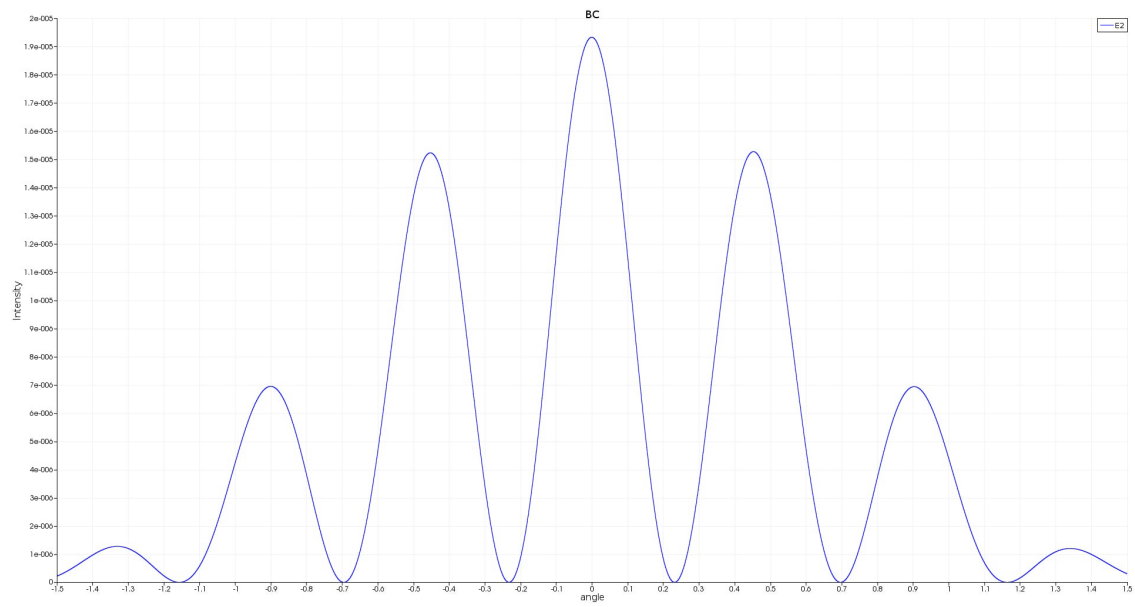

(b) Intensity at far field

Figure 13: Intensity distribution, slit B and C open

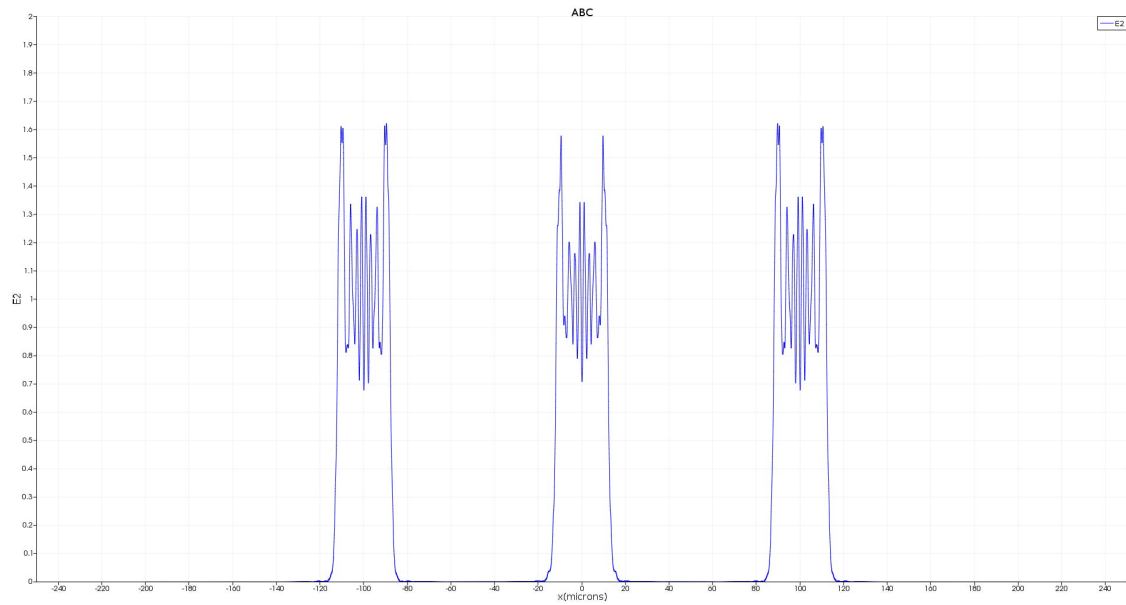

(a) Intensity at near field

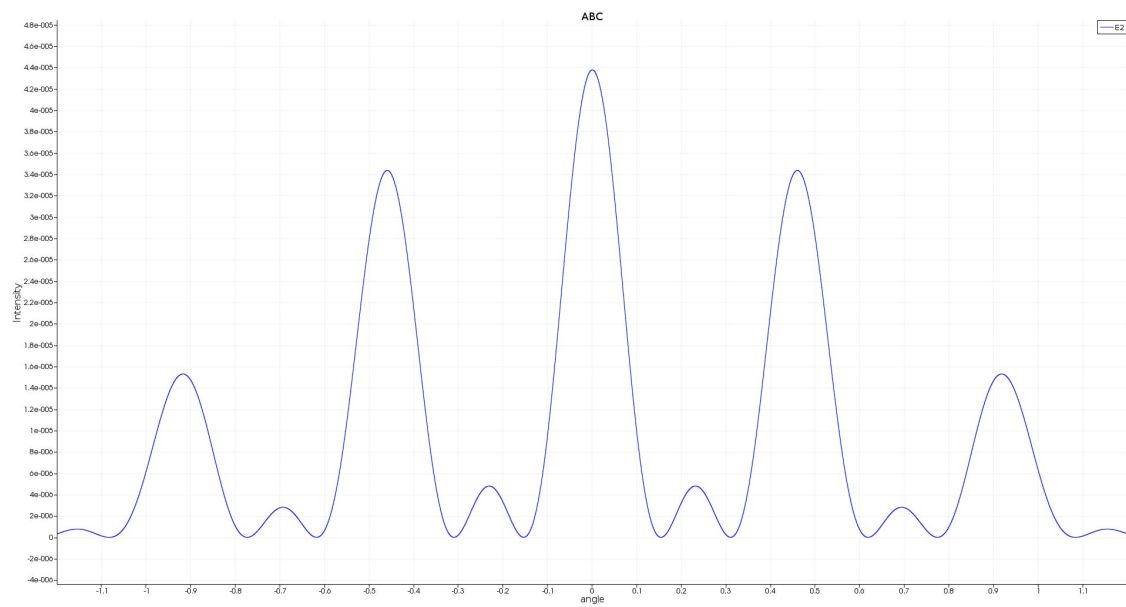

(b) Intensity at far field

Figure 14: Intensity distribution, all slits open

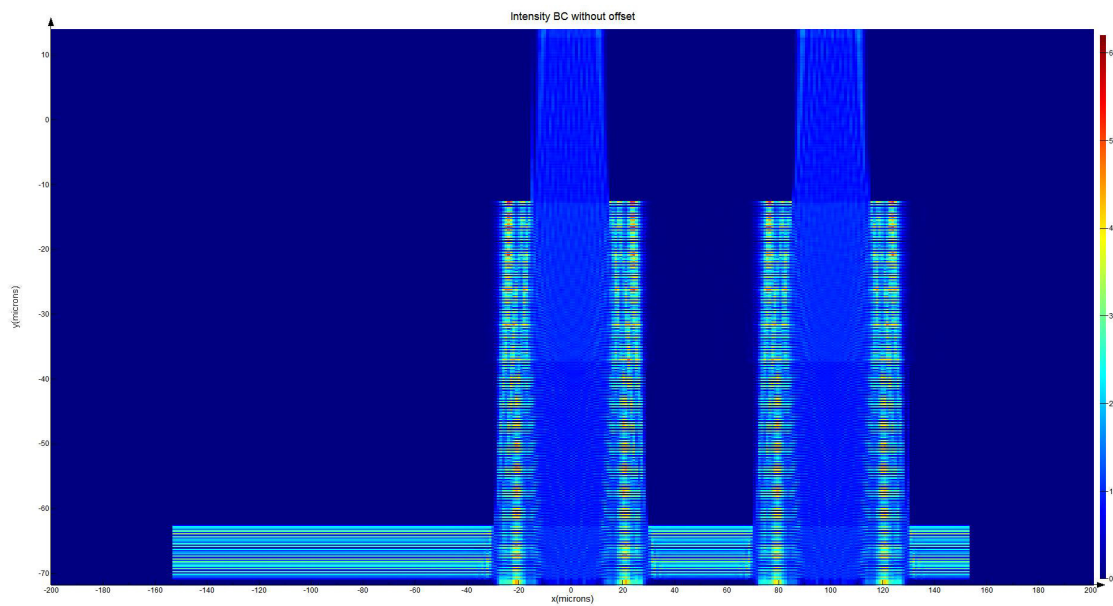

(a) Intensity without any offset

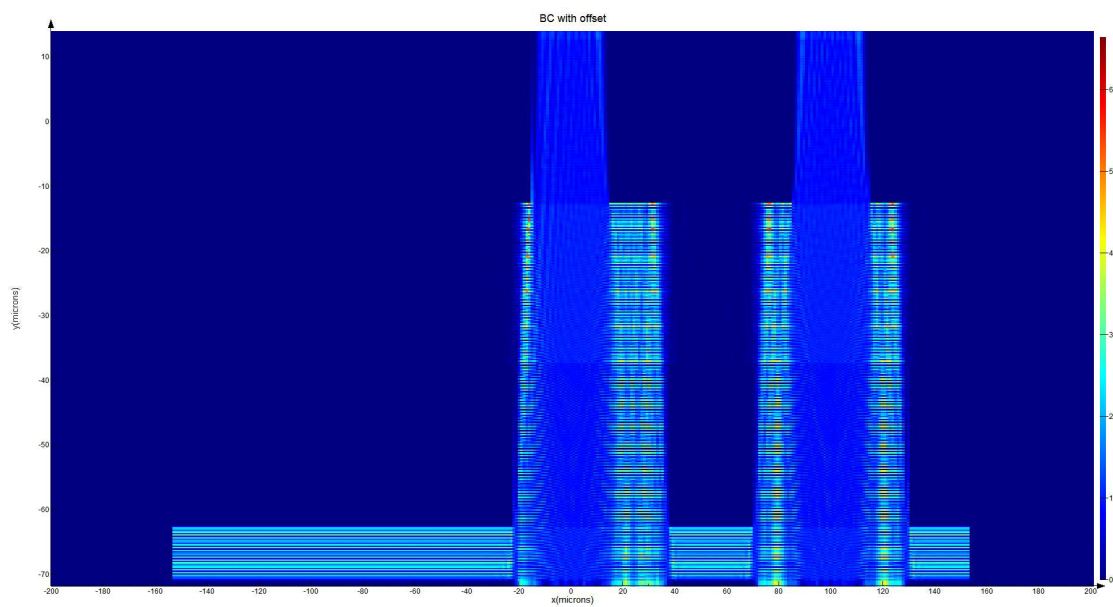

(b) Intensity with 8 microns offset

Figure 15: Comparison of the Intensities

5 Future work

The experiment is currently under progress. The proposed experiment will use two sources:

1. Attenuated laser source
2. Heralded single photon source

Single photon source is being developed as a technology in our lab right now. The experiment is going to be first of its kind which will serve as table top verification for the theory developed in our group which aims to find the correction term in the wave function hypothesis. If successful in finding this correction term, our work will have the potential of replacing some material existing in popular quantum mechanics textbooks.

The proposed set-up for our experiment using an attenuated laser source is illustrated in Fig 16. A pulsed laser source is attenuated and coupled into a Single mode fiber(**SMF**). In order to achieve the necessary attenuation, a combination of a half-waveplate, polarizing beam-splitter(**PBS**) and neutral density filters is used. The opening mask is connected a high precision linear actuator(**Actuator 1**) to switch between different combinations. The slit mask is kept stationary, while the opening mask will be translated. The diffracted light will be condensed vertically with a cylindrical lens (CL) onto a multi-mode fiber (**MMF**).The photons will be detected by a power-meter(**PD**) which is connected to the computer.

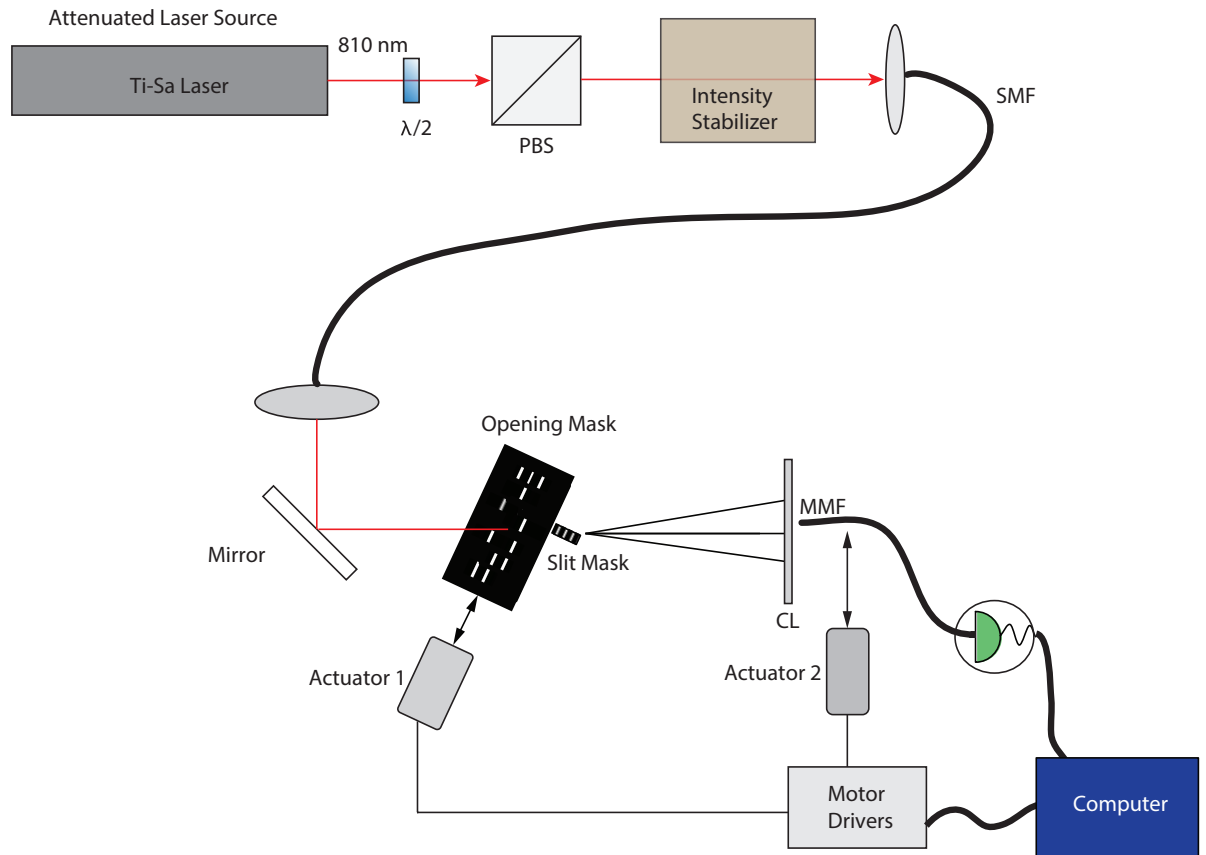

Figure 16: Experimental Setup using an attenuated laser source

References

1. R. Sawant, J. Samuel, A. Sinha, U. Sinha, Whirling waves in interference experiments, *arXiv quant-ph (1308.2022) (2013) 8*.
2. R. D. Sorkin, Quantum Mechanics , *arXiv gr-qc (9401003) (1994) 13*.
3. U. Sinha, C. Couteau, T. Jennewein, R. Laflamme, G. Weihs, Ruling Out Multi-Order Interference in Quantum Mechanics, *Science 23 July 2010 329 (5990) (2010) 418-421*.
4. U. Sinha, C. Couteau, Z. Medendorp, I. Sollner, R. Laflamme, R. Sorkin, G. Weihs, Testing Born's Rule in Quantum Mechanics with a Triple Slit Experiment, *arXiv quant-ph (0811.2068)*.
5. Feynman, R. P. and Hibbs, A. R. Quantum Mechanics and Path Integrals (*McGraw-Hill, New York, 3rd. ed. 1965*).
6. Feynman, R. P. Leighton, R. and Sands, M. The Feynman Lectures on Physics Vol. 3 (*Addison - Wesley, Reading Mass, 1963*).
7. Yabuki, H. Feynman path integrals in the young doubleslit experiment. *Int. J. Theor. Ph. 25, No.2, 159-174 (1986)*.
8. Cohen-Tannoudji, C. Diu, B. and Laloe, F. Quantum Mechanics I, (*Wiley - VCH, 2nd edition, 2005*)
9. M. Born, *Z. Phys. 37, 863 (1926)*.

ANIMESH AARYAN
animesh.aaryan@gmail.com